

PX818-3

PX818-4

PX818-5

Driver LED C.V. 3 x 5A

Driver LED C.V. 4 x 4A

Driver LED C.V. 5 x 3A

User manual



Table of Contents

1 Description.....	4
2 Safety conditions.....	5
3 Connectors and control elements.....	6
4 Designation of displayed messages.....	7
5 Device programming.....	9
5.1 Button features.....	10
5.2 DMX address setting.....	10
5.3 No DMX signal response.....	10
5.4 Smooth.....	12
5.5 Control curve selection.....	12
5.6 Light control frequency.....	14
5.7 Offset.....	14
5.8 Channel short circuit detection.....	15
5.9 White balance.....	16
5.10 Control modes.....	17
5.11 Master / Slave function.....	20
5.12 Screen saving.....	21
5.13 Temperature limitation.....	21
5.14 Output current reading.....	23
5.15 Default settings and device errors.....	23
5.15.1 Restore default settings.....	24
5.16 Information parameters.....	25
5.17 Display flip function.....	25
5.18 Error message.....	26
5.19 Device overloads.....	27
6 Device update.....	28
7 DMX signal connecting.....	29
8 Programming.....	30
9 Connection scheme.....	31
10 Dimensions.....	32
11 Technical data.....	33

Manufacturer reserves the right to make modifications in order to improve device operation.

PXM Marek Żupnik sp.k.

Podłęże 654

32-003 Podłęże

BDO register number 000005972

tel. +48 12 385 83 06

mail: info@pxm.pl

www.pxm.pl

Rev.1-0

15.02.2023

1 Description

The PX818 driver is designed to control LEDs. The device has been adapted to be mounted on a DIN rail and equipped with automatic current protection. The built-in DMX receiver allows to control 3 / 4 / 5 channels (R, G, B / R, G, B, W / R, G, B, WW, CW). A wide range of supply voltage and high current carrying capacity of the outputs (5A / 4A / 3A) enable the control of a large number of LEDs.

The PX818 can be controlled by the DMX signal or it can work independently. In such operation mode, the user has access to a fully programmable scene. Thanks to the interpolated resolution of the output control at the 16 bit level, the control of the parameters of individual channels is completely smooth. Moreover, the driver offers an effect control mode which allows for controlling the programs that are built into the device and, at the same time, changing such parameters as speed, brightness and fade settings using the DMX-512 signal sent from an external controller.

PX818 also supports RDM protocol with its extension of DMX-512 protocol.

The driver offers a built-in control signal frequency tuning system ("*flicker free*" technology), which makes it useful in applications for the television industry. The refresh rate of the signal can be set to 1.5 / 3 / 6 / 12 / 24 kHz. As LEDs from the RGB, RGBW series often differ in parameters, problems in receiving white color may occur (triggering 100% at all channels). This is why the PX818 has been equipped with a very useful feature called "white balance". With this feature, each set of LEDs can be adjusted so that the

control of individual colors by the module enables achieving white color at full activation. What is more, this feature allows for adjusting color temperature of white output color.

2 Safety conditions

PX818 is a device powered with safe voltage 12 – 24V; however, during its installation and use the following rules must be strictly observed:

1. The device may only be connected to 12 – 24V DC with current-carrying capacity compatible with technical data.
2. All the conductors should be protected against mechanical and thermal damage.
3. In the event of damaging any conductor, it should be replaced with a conductor of the same technical data.
4. Only use a shielded cable to connect the DMX signal.
5. All repairs and connections of outputs or DMX signal can only be made with cut off power supply.
6. PX818 should be strictly protected against contact with water and other liquids.
7. All sudden shocks, particularly dropping, should be avoided.
8. The device cannot be turned on in places with humidity exceeding 90%.
9. The device cannot be used in places with temperature lower than +2°C or higher than +40°C.
10. Clean with damp duster only.

3 Connectors and control elements

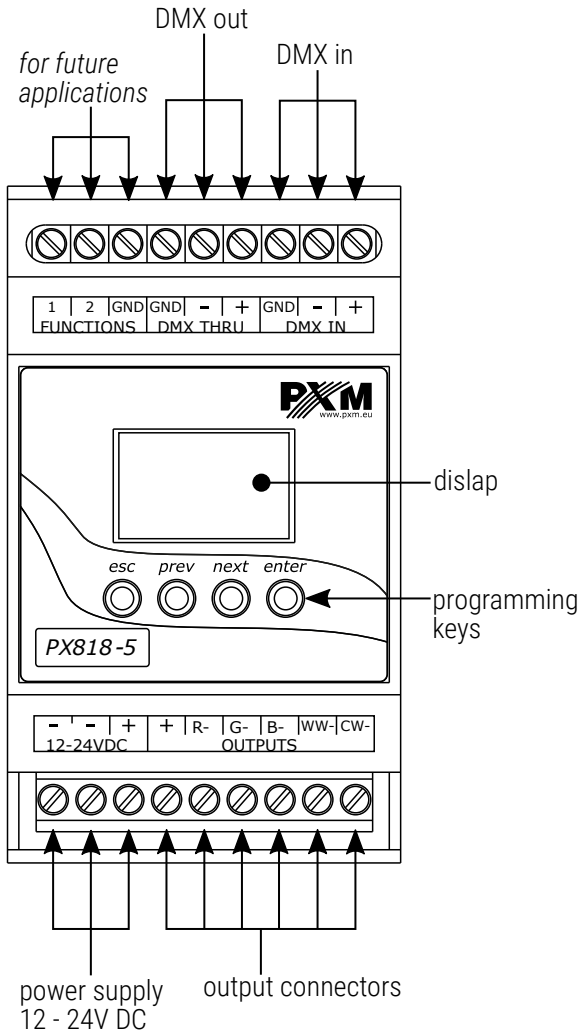







4 Designation of displayed messages

- 000.** DMX address of a device – a basic item in the MENU
- 888.** DMX address setting
- 889.** no DMX signal response method selection
- 588.** smoothing level
- 000.** Master / Slave mode settings
- 000.** selection of the control curve
- 000.** setting the linear control curve
- 880.** setting the DALI control curve
- 880.** exponential
- 880.** exponential
- 820.** exponential
- 089.** offset
- 088.** control method selection (RGB, Lightness / Color, etc.)

5 channels		4 channels		3 channels	
886.	1 brightness channel				
856.	RGB/WW/WC	846.	RGBW	836.	RGB
588.	RGB/WW/WC + Dimmer	488.	RGBW + Dimmer	388.	RGB + Dimmer
880.	RGB + DW	880.	(RGB + Dimmer) + 1	880.	DW + 1
882.	(RGB + DW) + Dimmer	X	X	X	X

8H3.	(RGB + Dimmer) + DW	X	X	X	X
880.	DW + DW + 1	880.	DW + DW	880.	DW + 1
8FF.	effect control mode				

- 88A.** all outputs at 100%
- 8FF.** all outputs off
- 520.** scene
- 880.** maintain last DMX value
- 5HE.** short circuit detection of output channels
- 08A.** Master mode on / off
- 0HA.** number of channels being sent in the Master mode
- 680.** white color balance setting
- 600.** white balance for channel 1
- 260.** channel one when programming a scene
- 88A.** basic frequency of brightness control
- 50A.** screen blanking
- 60A.** temperature settings
- 800.** temperature value from which limiting of output power is activated
- 88A.** temperature value for which the outputs from the device are completely turned off
- 680.** current temperature
- 65H.** the highest temperature recorded by the sensor
- 650.** the lowest temperature recorded by the sensor

	output current
	total output current
	output current on channel 1
	restore default device settings menu
	firmware version
	device serial number
	memory error message

When the master function is active, the LED located in the lower right corner of the screen starts flashing with a frequency of 0.25 Hz. However, when receiving a DMX signal, the frequency increases 2 times to 0.5 Hz.

5 Device programming

After you switch on the module, its display shows the program version for a brief moment. To access the main menu, press *enter*, and the display will show **Adr**. Press *prev* or *next* to select the appropriate menu, and press *enter* to confirm your selection.

5.1 Button features

- esc** – goes back to the previous MENU level or discards changes made
- prev** – scrolls to the previous feature on the same MENU level or decreases the parameter's value
- next** – scrolls to the next feature on the same MENU level or increases the parameter's value
- enter** – enters the next MENU level and confirms changes made

5.2 DMX address setting

The PX818 driver menu allows you to set the DMX address of the device in the range of 1 – 512.

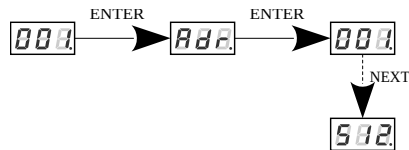

5.3 No DMX signal response

This function is used both to protect the installation against the DMX signal loss and to obtain control over LEDs without connecting an external controller. Once it is activated, if there is no DMX signal, the module will realize a desired function independently.

Reconnecting the DMX signal will automatically break the realized function and the module will once again follow the commands transmitted via the DMX line.

- *oFF* – disabling all outputs after DMX signal loss,
- *on* – activation of all outputs at 100% after decay DMX signal,
- *Hld* – maintaining the last value of DMX signal,
- *Sc* – self-programmed scene in which you can set values for channels 1 – 3 / 4 / 5 (depending on the version),
- *EFF* – effect mode.

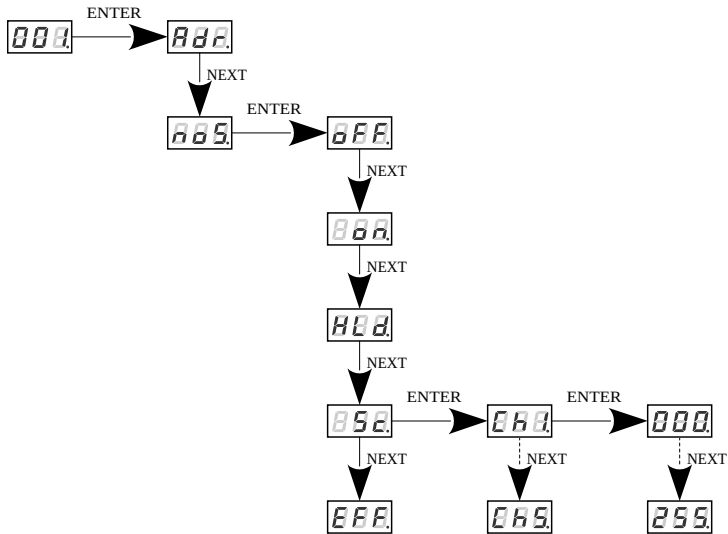

5.4 Smooth

The device also has the **Sth** smooth function. Smooth feature allows for smooth changes in lightness and color. When it is set to On the transition between successive DMX values sent to the lamp (e.g. corresponding to changes in lightness) are smooth with no visible twitches, which prevents the common light “vibrations” effect. This function can be turned **OFF** or set on a level between 1 and 5, where 5 means very smooth transitions between individual control values.

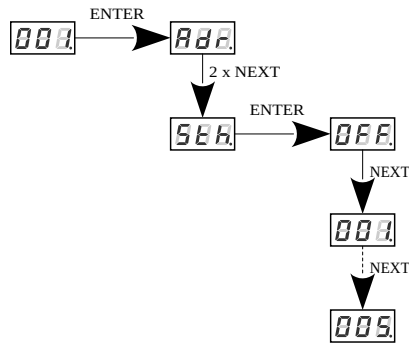

5.5 Control curve selection

The driver has implemented the ability to select one of the five output control curves:

- linear **Lin** – the output value is linearly proportional to the control value,
- DALI **dAL**,
- **E1u, E2u, E1** – exponential curves.

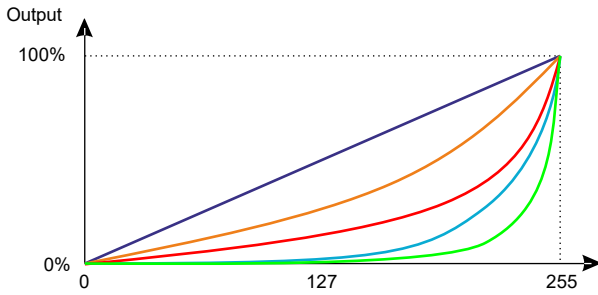
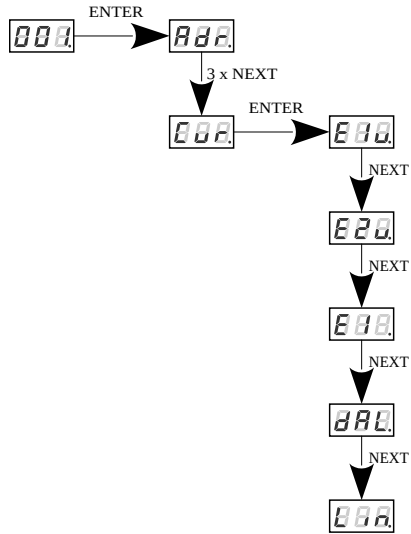

Curves:

- linear
- E1
- E1u
- E2u
- DALI

5.6 Light control frequency

The *Frq* function allows for setting the basic control frequency for the LEDs. This function is extremely useful in applications for the television industry. By applying the "flicker free" technology, it is possible to avoid the unpleasant flickering effect which is caused by improper signal synchronization that controls the LEDs – using a control frequency of 3kHz or more. The user can choose from the available frequency range from 1.50kHz up to 24kHz which can be smoothly changed using the *prev* or *next* buttons and confirm your selection with the *enter* key.

The frequency value in the upper range (e.g. 1.50 = 1.5kHz) helps to avoid the flickering effects that are visible in video cameras.

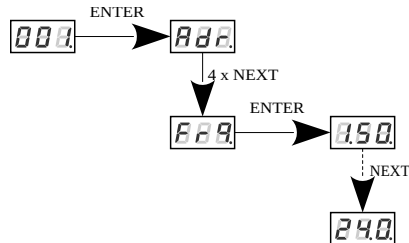

5.7 Offset

This option allows you to set the level of switching on the LEDs. This function is useful when the user has LEDs, which, for example, when the DMX value on the channel is 10, and the LEDs are still not lit. By changing the settings of this parameter, the user can change the parameters so that the LEDs light up when the DMX channel is set to 1.

It is possible to set the value in the range of 0 – 10000.

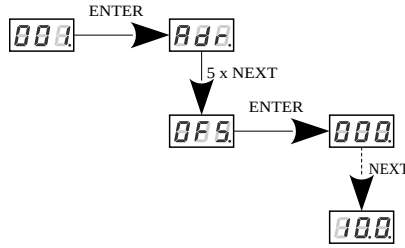

Offset = 0

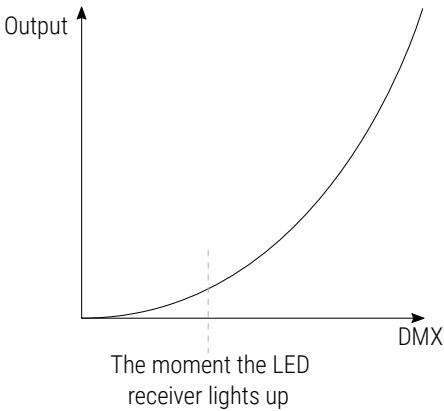

Offset = adapted to the LED receiver's operating characteristics

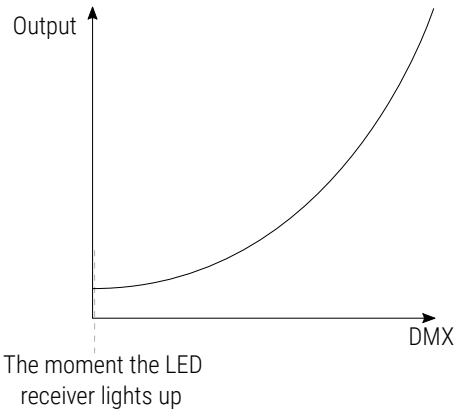

5.8 Channel short circuit detection

Channel short circuit detection (**SHt**) is an option that protects the device against damage in the event of a short circuit of the outputs. When the driver detects a short circuit, the channels are immediately switched off, and the **SHt** message flashes on the main screen. In order for the device to return to normal operation, it is necessary to eliminate the short circuit between the channels and restart it (switch the power off and on or enter the **vEr** menu and hold down the enter key – the device will restart).

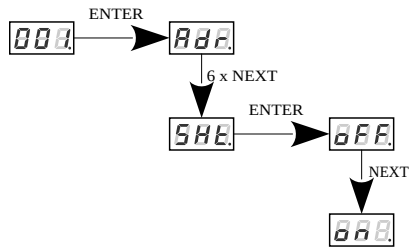

5.9 White balance

Sometimes, there can be problems with getting white color LEDs. This may be a result of using diodes with different technical parameters. For this reason, the PX818 module is equipped with a white balance function.

With this option, you can choose the right color temperature for full control of all outputs (white). Depending on the version, the user can configure 1 – 3 / 4 / 5 channels.

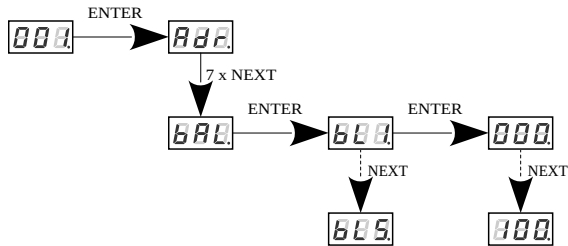

5.10 Control modes

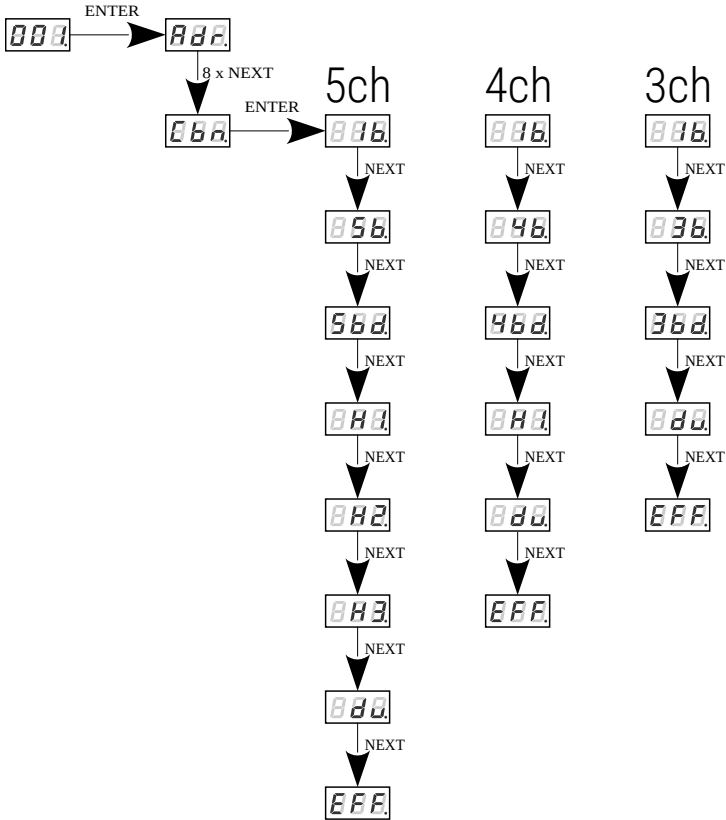

The PX818 driver can operate in various control modes. Depending on the selected mode, the device occupies a different number of channels.

Depending on the version of the device, other modes are available:

- **1b** – one channel is responsible for controlling the brightness of all outputs,
- **5b / 4b / 3b** – it is possible to control each channel individually,
- **5bd / 4bd / 3bd** – the user can control each channel individually, additionally on channel 6 / 5 / 4 (depending on the version) the Dimmer function is implemented – dimming all outputs,

- **H1:**
 - 5ch – RGB control + dynamic white,
 - 4ch – RGB with dimmer + one individual channel,
- **H2:**
 - 5ch – RGB + dynamic white + dimmer on all channels,
- **H3:**
 - 5ch – RGB with dimmer + DW,
- **du:**
 - 5ch – 2 x dynamic white + one individual channel,
 - 4ch – 2 x dynamic white,
 - 3ch – 1 x dynamic white + one individual channel,
- **EFF** – control of the strobe effect, operates on 10 DMX channels and allows you to choose its appropriate parameters (description of the **EFF** mode is on the next page).



NOTE! In DW (dynamic white) mode, the first channel is responsible for the color temperature, the second for brightness.

Description of the **EFF** – effect mode:

- **channels 1 – 5:**
 - 5ch – R / G / B / WC / WW,
 - 4ch – R / G / B / W,
 - 3ch – R / G / B,

NOTE! In the 4ch version, channel 5 is inactive, while in the 3ch version, channels 4 and 5.

- **channel 6** – lightness settings (higher value – stronger glow),
- **channel 7** – inactive – for future use,
- **channel 8** – speed settings (higher value – quicker changes),
- **channel 9** – fade settings (higher value – smoother transition),
- **channel 10** – so-called filling – operation is presented below.

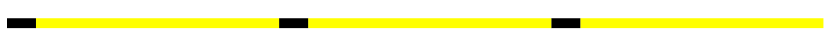
DMX	Channel 10 (effect)
e.g.5	
e.g.128	
e.g.250	

NOTE! By setting "fill" to extreme values, the effect may be invisible. It is not recommended to set extreme DMX values (0 and 255). A value of 0 will cause the diodes to go out completely, while a value of 255 will keep them on.

5.11 Master / Slave function

The PX818 module has a built-in DMX-512 receiver and can be controlled from any desktop or controller running in this standard. Moreover, it is equipped with a programmable function of response to no DMX signal (*noS*). However, in larger installations, several PX818 drivers implementing the same program cannot provide a full playback synchronization. Therefore, PX818 has a Master feature. When it is activated, the module changes from a DMX receiver into a transmitter of this signal and sends programs to the other modules (which are set as Slave).

With this solution, it is possible to make a precise synchronization even in very large installations without using an external controller.

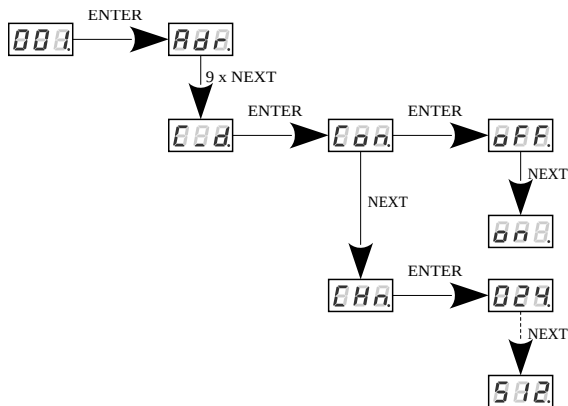

- **Con** – turning **on** or turning **off** the Master mode,
- **Chn** – the number of DMX channels sent.

In case when Master feature is active, dot in the lower right corner starts to blink with 0.25Hz frequency. When the PX818 is receiving DMX signal, it starts to blink with 2-times bigger frequency (0.5Hz).

5.12 Screen saving

The device is equipped with a feature that allows for turning off the backlight. This option is marked with the **Scr** sign. With this feature, the display is turned off after about 60s (if the keys of the device are not pressed). Of course, the device continues its operation without interfering with other parameters. Press any key to restore the backlight.

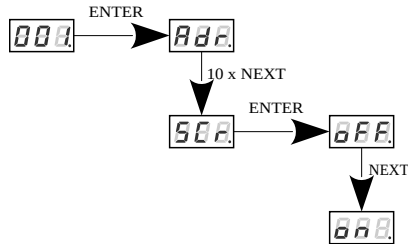

5.13 Temperature limitation

PX818 has been equipped with the function of limiting the output power depending on the temperature value read from the sensor in the housing.

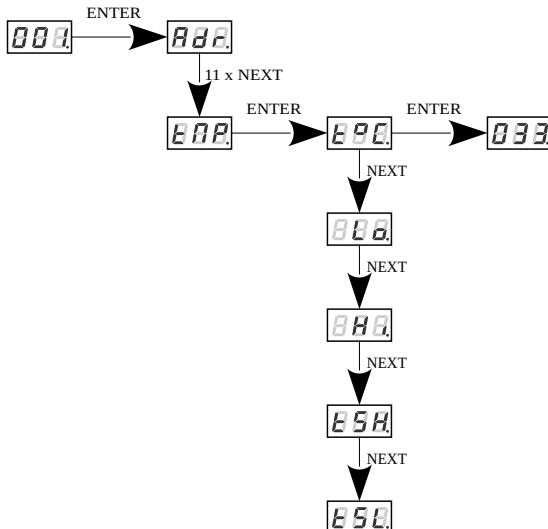

The meaning of the statement:

- **tMP** – power limitation management depending on temperature read on the sensor,
- **Lo** – limit activation temperature value default set to +70°C,
- **Hi** – maximum limit temperature value default set to +90°C,
- **t°C** – current temperature,
- **tSH** – the highest temperature recorded by the sensor,
- **tSL** – the lowest temperature recorded by the sensor.

The course of the power limitation between **Lo** and **Hi** values is linear as shown in the graph below:

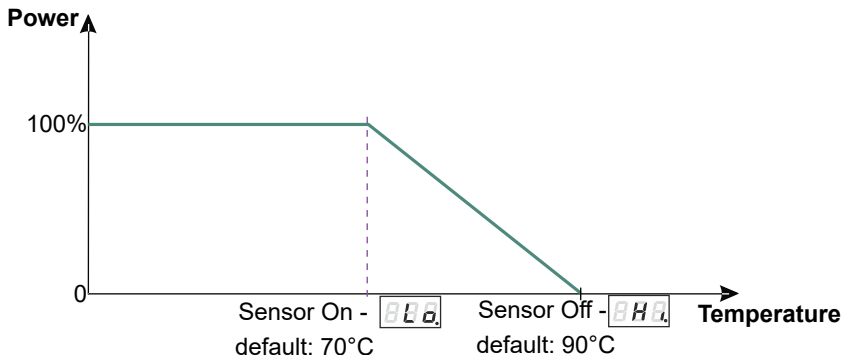

5.14 Output current reading

PX818 has a system that makes it possible to read the total current on the outputs and on individual channels.

Values are in [A]. Depending on the version, a different number of channels is displayed.

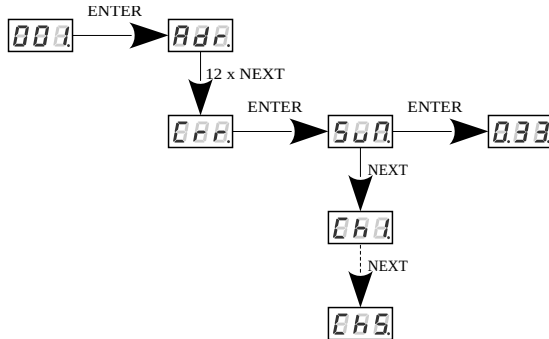

5.15 Default settings and device errors

If you have any difficulty accessing the device menu, e.g. it is not possible to enter a particular menu level, or it is necessary to restore the device to its default settings, follow the instructions below.

In the first case, when a particular menu level cannot be accessed or menu items are displayed incorrectly, this may indicate that a saving-in-memory error has occurred. In such a case, try to restore the device to its default settings before sending the PX818 to the service center. If, after restoring to its default settings, the device still does not operate correctly, please send it to our service center.

5.15.1 Restore default settings

To restore the default settings, hold down the *prev* key while powering on the device. Then, among the appearing messages, **dFl** will appear, which means restoring the default settings (during switching on the power supply, until the **dFl** message is displayed, the *prev* button must be pressed).

Accepting this message with the *enter* key restores the default settings. It is also possible to exit this menu without returning to the default settings. In this case, select the *esc* key.

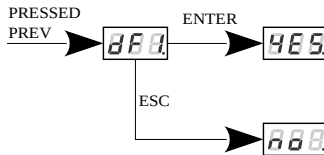

Default settings can also be restored from the main menu.

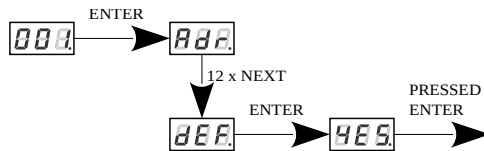

NOTE! Keep the *enter* button pressed until the screen flashes.

Please note that after restoring to default settings, all the operating parameters of the device will revert to the following ones:

- **DMX address:** 1
- **no signal:** oFF
- **smooth:** 003
- **curve:** E1u
- **frequency:** 1.50

- **offset:** 000
- **short circuit detection:** on
- **white balance:** *all channels 100%*
- **driver mode:** 5b / 4b / 3b (depending on version)
- **master mode:** disable
- **number of DMX channels sent:** 128
- **screensaver:** oFF

5.16 Information parameters

PX818 allows to display information on the **vEr** software version and the **Sn** serial number on the device screen.

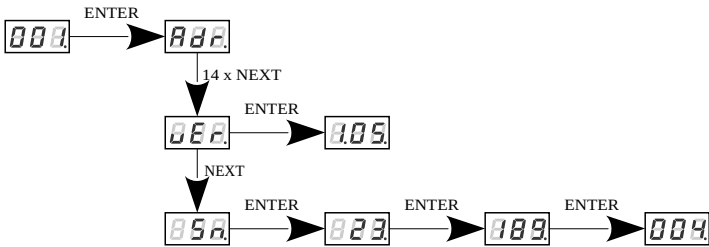

Example serial number: 23 189 004

5.17 Display flip function

As the driver should be installed (As far as possible) in a small distance from the controlled LEDs, the lack of space may force the necessity of mounting the device upside-down. In such case the displayed messages become illegible, that does not have the influence on device operation, but makes the programming much more difficult.

That is why PX818 has been equipped with a function that allows to flip the screen by 180° and change the setting of the programming keys.

To do this, simultaneously press and hold for about 3s the two middle keys of the device (prev and next).

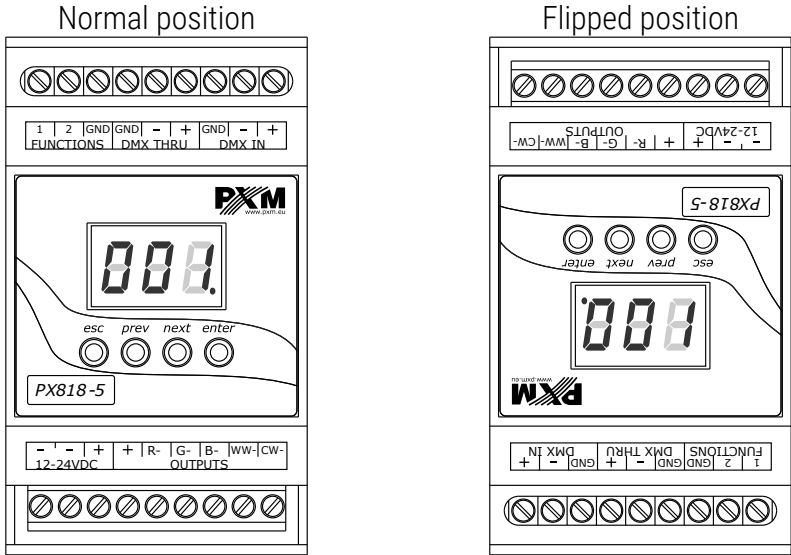

NOTE! After inverting the display, the keys are set analogously to the normal position, they are inverted. Inverted, *esc* is *enter*.

5.18 Error message

The device is equipped with a built-in memory work control function. If there are problems with the memory operation on the PX818 display, the **Err** message appears – memory error.

In this situation, select the *enter* key. The device will reload the default configuration and upload it to the memory. If after this operation, the **Err**

message remains on the screen, the memory is permanently damaged and the unit must be sent to the service point.

5.19 Device overloads

The driver is protected against exceeding the permissible load per channel by 1A. In the event of exceeding the permissible load, an error begins to be displayed on the display indicating the number of the output on which the overload occurs. When the device detects an overload, the driver turns the channel off and then on again to check if the overload still occurs.

The device is also protected against channel short circuit – the *SHt* message is displayed.

Below are sample messages displayed by the device for overloaded individual channels and a short circuit of any output channel while the PX818 is operating.

Channel 1 (R)	Channel 2 (G)	Channel 3 (B)	Channel 4 (WW)	Channel 5 (WC)	Short circuit
001.	002.	003.	004.	005.	SHt.

NOTE! When the device detects a short circuit on one of the outputs and the *SHt* message appears, you must turn the device off, eliminate the short circuit and turn it on.

6 Device update

The update is possible using the [PX313 USB / RS485 In](#) device – details can be found in the manual for this module.



The device update was also presented in detail on our YouTube channel.

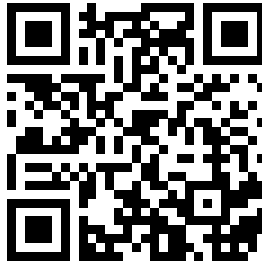

https://www.youtube.com/watch?v=ISIFGeXVR_k

7 DMX signal connecting

PX818 have to be connected to DMX line in serial mode, with no branches on DMX control cable. That means that DMX line, from the signal source, must be connected to **DMX IN** pins of PX818 and later, directly from **DMX THRU** pins to the next device in DMX chain.

If the PX818 is the last DMX chain receiver, there should be a terminator (resistor 120 Ohm) mounted between "**DMX+**" and "**DMX-**" pins of **DMX THRU** section.

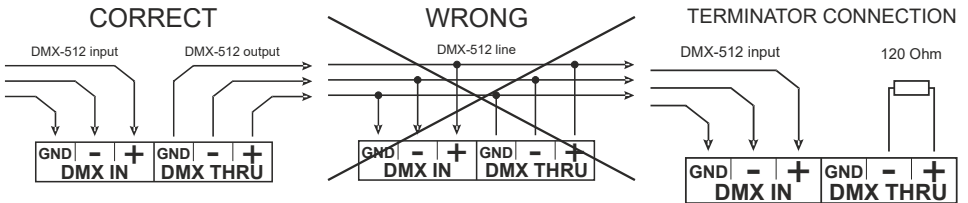

9 Connection scheme

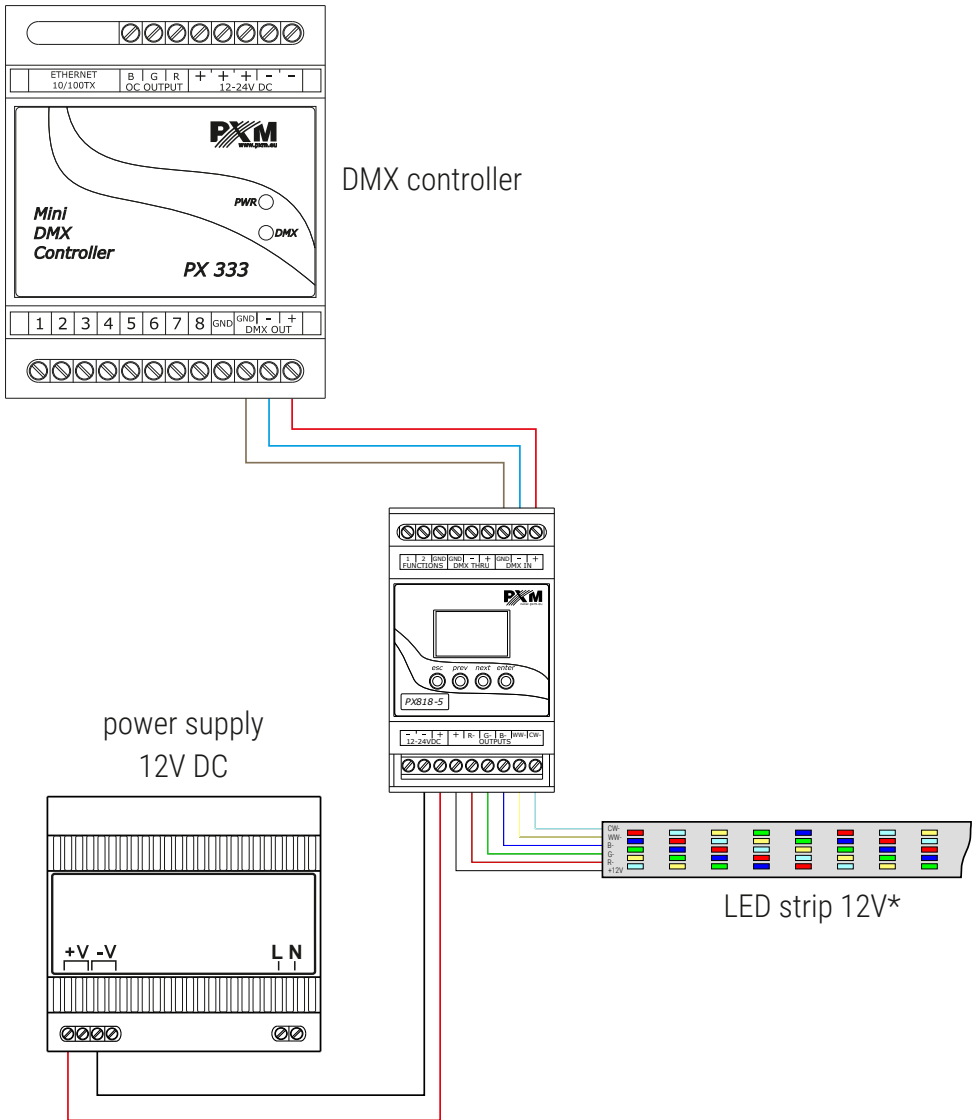

* typical LED strips are supplied with 12V DC – then the PX818 has to be connected also the 12V DC power supply with adequate power, in the case of

using LED strips supplied with 24V DC, the PX818 has to be connected to 24V DC power supply that power is matched to the length of the strip.

NOTE! The arrangement of connectors in PX818-3 and PX818-4 may differ from the version shown in the example connection diagram above (PX818-5).

10 Dimensions

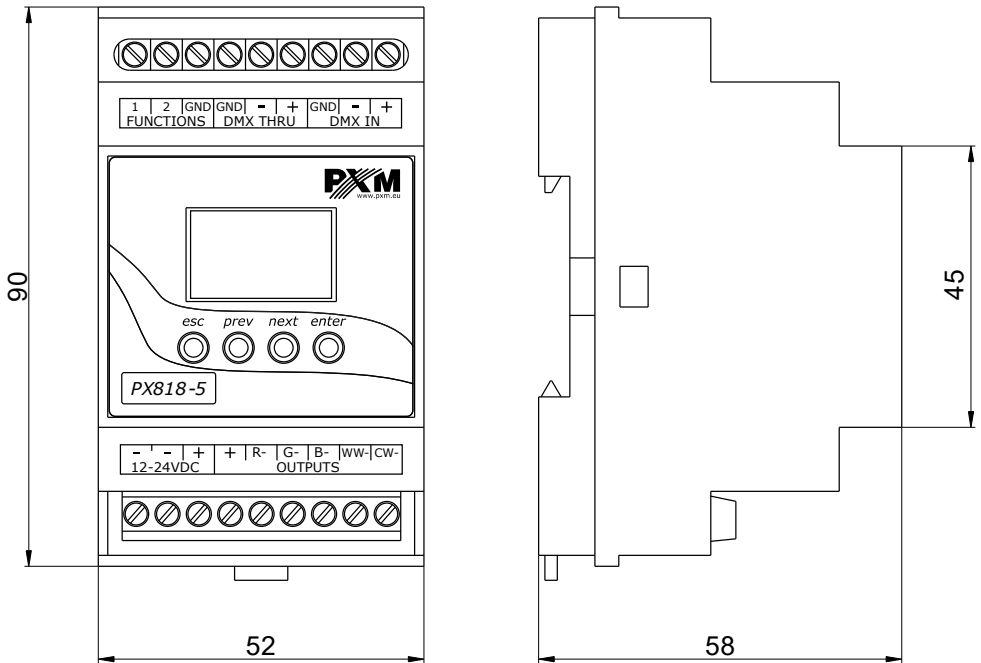

NOTE! The arrangement of connectors in PX818-3 and PX818-4 may differ from the version shown in the technical drawing above (PX818-5).

11 Technical data

	PX818-3
type	PX818-4
	PX818-5
DMX channels	512
RDM protocol support	yes
power supply	12 – 24V DC
max. current consumption	16A
power consumption without load	max. 0.8W
output channel number	3 / 4 / 5 (depending on version)
interpolated resolution of output control	16 bit
programmable scenes	1
outputs current capacity	3A / 4A / 5A / channel (depending on version)
output sockets	screw connectors
Master / Slave mode	yes
weight	0.2kg
dimensions	width: 52mm (3 DIN rail modules) height: 90mm depth: 58mm

DECLARATION OF CONFORMITY

PXM Marek Żupnik spółka komandytowa
Podłęże 654, 32-003 Podłęże

we declare that our product:

Product name: Driver LED C.V. 3 x 5A
Driver LED C.V. 4 x 4A
Driver LED C.V. 5 x 3A

Product code: PX818-3 / PX818-4 / PX818-5

meets the requirements of the following standards, as well as harmonised standards:

PN-EN IEC 63000:2019-01	EN IEC 63000:2018
PN-EN 61000-4-2:2011	EN 61000-4-2:2009
PN-EN IEC 61000-6-1:2019-03	EN IEC 61000-6-1:2019
PN-EN 61000-6-3:2008	EN 61000-6-3:2007

and meets the essential requirements of the following directives:

2011/65/UE **DIRECTIVE OF THE EUROPEAN PARLIAMENT AND OF THE COUNCIL** of 8 June 2011 on the restriction of the use of certain hazardous substances in electrical and electronic equipment
Text with EEA relevance.

2014/30/UE **DIRECTIVE OF THE EUROPEAN PARLIAMENT AND OF THE COUNCIL** of 26 February 2014 on the harmonisation of the laws of the Member States relating to electromagnetic compatibility (recast)
Text with EEA relevance.

Marek Żupnik spółka komandytowa
32-003 Podłęże, Podłęże 654
NIP 677-002-54-53



mgr inż. Marek Żupnik.