



Device description

PX796-IP, depending on the configuration, can be a transmitter or a receiver of a wireless DMX signal.

Wireless DMX is a device that allows you to connect easily, without using wires, installations based on the DMX512 control system. In order to create an installation using wireless DMX signal transmission, two devices of this type should be used, set in transmitting and receiving mode (works with PX795 and PX796).

Configuration is very simple and is carried out at the touch of a button. The 2.4GHz band in which communication occurs ensures long range and unnoticeable delays.

The PX796-IP has a plastic housing suitable for wall mounting, with a protection class of IP65. It is powered by 230V AC mains voltage. The set includes an external directional antenna with a 1m long cable ended with a male SMA/RP plug. By default, the device is programmed in the transmitter mode.



Technical drawing

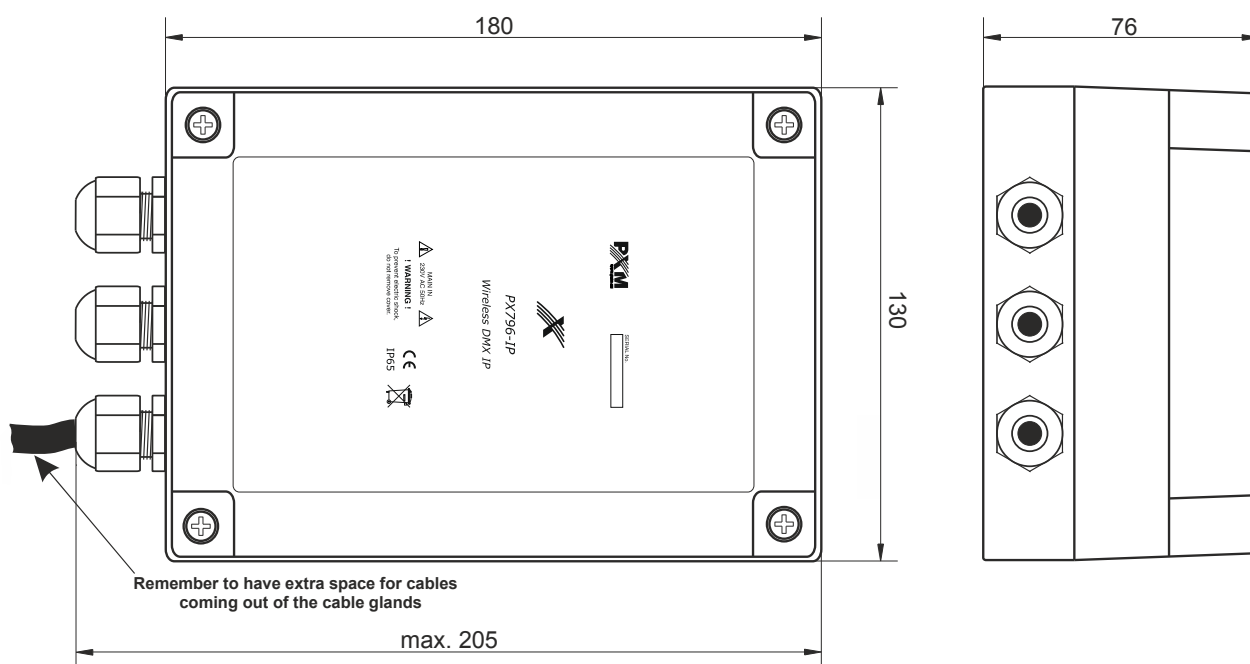

Connection diagram

a) device connection diagram

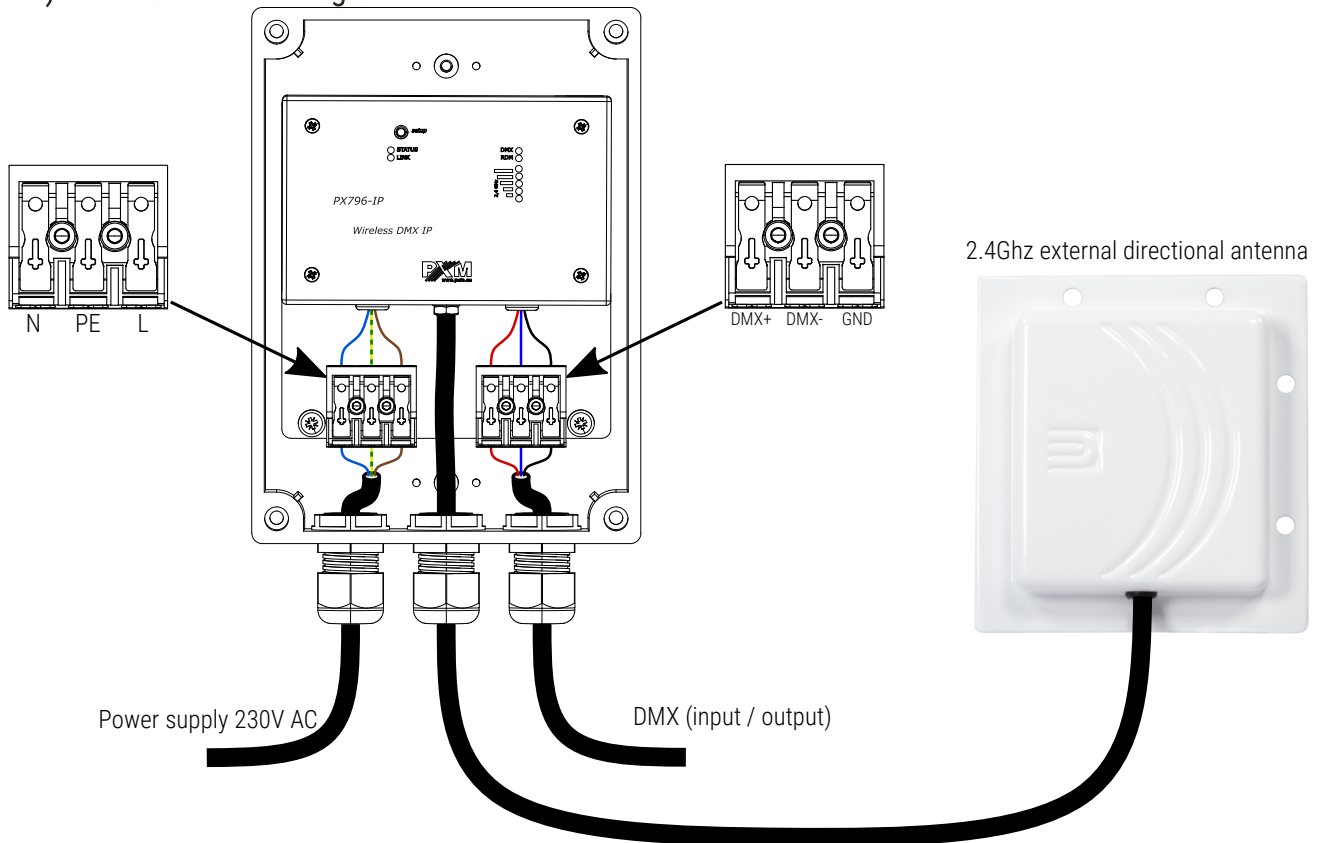

b) device operation diagram

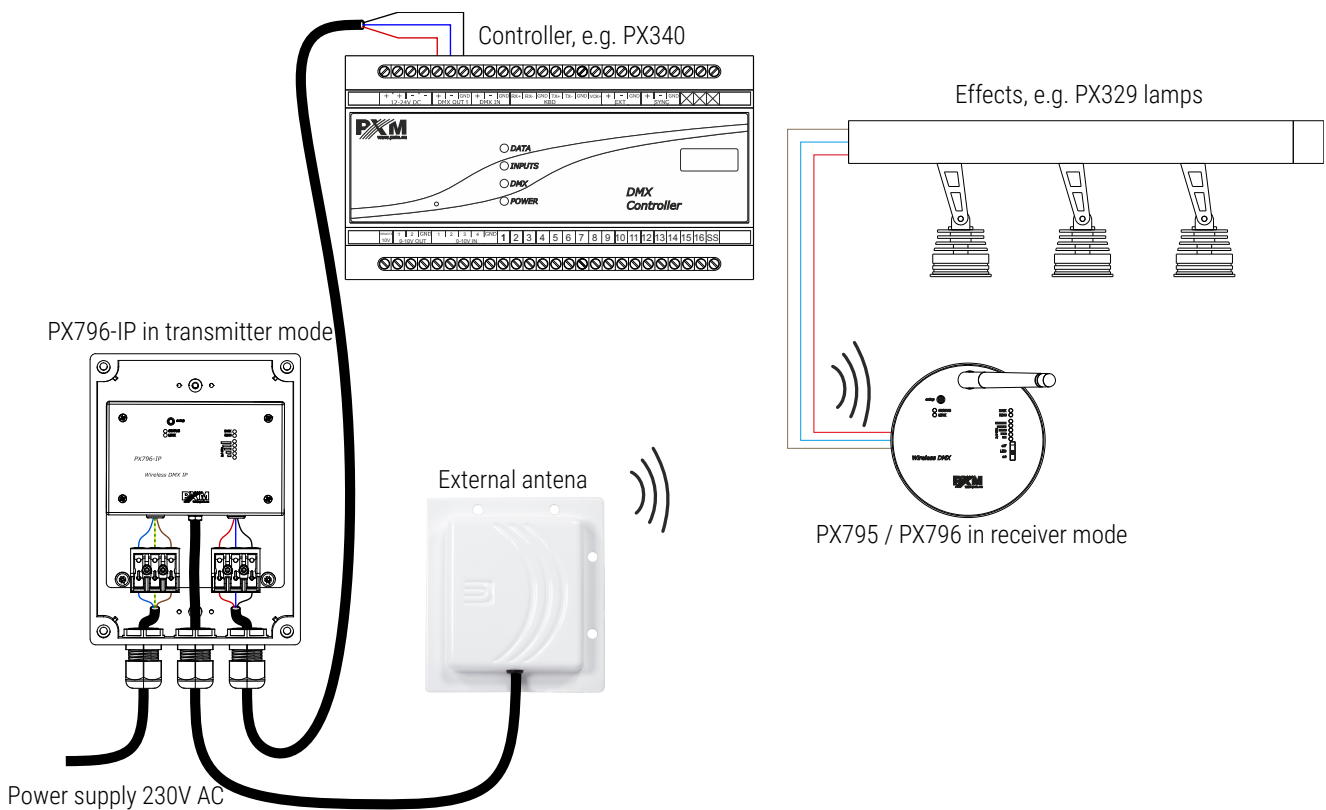

NOTE! PX796-IP can also operate in receiver mode.

Technical data

type	PX796-IP
power supply	230V AC
number of DMX channels	512
RDM protocol support	yes
transmission speed	0.8 – 830 fps
output power	5 – 20 dBm
frequency	2.4GHz
range (receiver – transmitter)*	max. 1km
operating mode	transmitter / receiver
IP rate	IP65
power consumption	max. 1W
antenna	polarization: vertical / horizontal main beam width: 70° maximum gain (without cable attenuation): 8dBi output impedance: 50Ω connector: SMA/RP cable length: 1m
weight	0.6kg
dimensions	width: 130mm height: 180mm depth: 76mm

* - in open space and in favorable weather conditions, without any obstacles between devices