

PX763

Driver LED C.C.

36 x 350mA

User manual



Table of Contents

1 Description.....	3
2 Safety conditions.....	4
3 Connectors and control elements.....	5
4 DMX signal connection.....	6
5 Meaning of displayed messages.....	6
6 Device programming.....	8
6.1 Button features.....	8
6.2 DMX addressing.....	9
6.3 Operation mode.....	11
6.4 Response to the lack of DMX signal.....	13
6.5 The smoothing function.....	15
6.6 Frequency of PWM signals.....	16
6.7 Minimum level of brightness.....	17
6.8 White balance.....	18
6.9 Screen saving.....	19
6.10 Temperature.....	19
6.11 Default settings and memory error.....	20
6.12 Software version.....	21
6.13 Rotation of the display.....	21
6.14 Service mode.....	22
7 RDM description of available parameters.....	23
8 Programming.....	28
9 Connection scheme.....	29
10 Dimensions.....	30
11 Technical data.....	31

Manufacturer reserves the right to make modifications in order to improve device operation.

PXM Marek Źupnik sp.k.

Podłęże 654

32-003 Podłęże

BDO register number 000005972

tel. +48 12 385 83 06

mail: info@pxm.pl

www.pxm.pl

Rev.1-2

29.04.2020

1 Description

The PX763 is a 36-channel current driver created with a view to RGB and RGBW matrix systems, which is perfectly suitable for controlling lighting of large surfaces consisting of a lot of module elements. Facades may be such an example – LED screens or illuminated floors. Using the built-in DMX signal receiver, it is possible to control all 36 channels with the DMX512 protocol. Supply voltage of 12V DC and high current capacity of outputs (max. 350mA) enable to connect a big number of LEDs – and in consequence, the effect of even illumination of the whole surface is obtained. The applied interpolated resolution of the output control 12bit for 330Hz and 10bit for 1.3kHz makes the brightness control of individual channels completely smooth. The additional advantage is implementation of modern technology “*flicker free*” i.e. a possibility to select frequency of 1.3kHz. Applying it, the PX763 driver can be successfully used in installations created for the needs of the television industry. Moreover, the RDM protocol was implemented in the PX763.

The device includes: channel addressing, 18 built-in programs and one scene, which can be programmed. The programs can be restored if the DMX signal disappears or in the effect mode.

The small flat casing of the device is adapted for wall mounting, screw connections allow for quick and easy connection of power supply and DMX signal, while connecting the output channels is tool-free thanks to the use of connectors with spring clamps.

2 Safety conditions

The PX763 is a device powered with safe voltage up to 12V DC; however, during its installation and use the following rules must be strictly observed:

1. The device may only be connected to 12V DC (stabilized voltage) with current-carrying capacity compatible with technical data.
2. All the conductors should be protected against mechanical and thermal damage.
3. In the event of damaging any conductor, it should be replaced with a conductor of the same technical data.
4. Connection of DMX signal can only be made with shielded conductor.
5. All repairs and connections of outputs or DMX signal can only be made with cut off power supply.
6. The PX763 should be strictly protected against contact with water and other liquids.
7. All sudden shocks, particularly dropping, should be avoided.
8. The device cannot be turned on in places with humidity exceeding 90%.
9. The device cannot be used in places with temperature lower than 2°C or higher than 40°C.
10. Clean with damp duster only.

3 Connectors and control elements

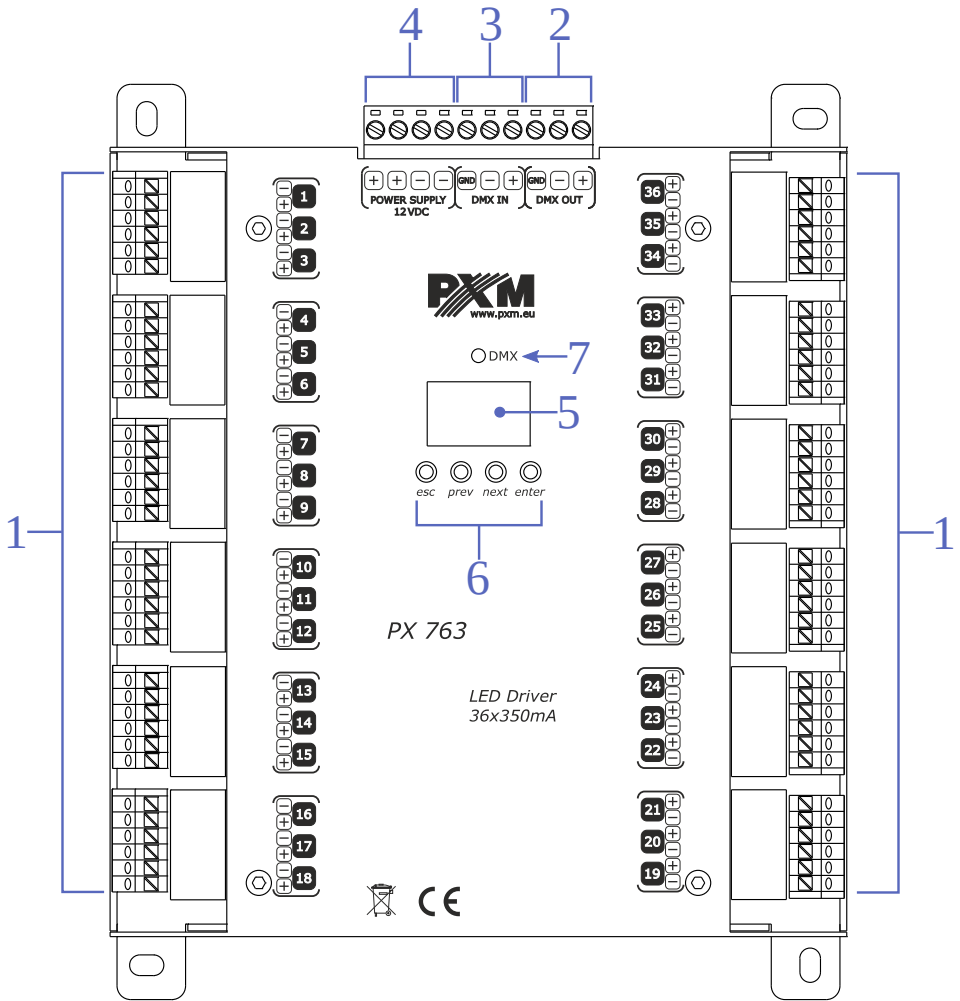

- 1. Driving outputs: 36 (OUTPUTS)
- 2. DMX OUT
- 3. DMX IN
- 4. Power supply
- 5. LED display
- 6. Driving buttons
- 7. Diode of DMX signal

4 DMX signal connection

PX763 must be connected to DMX line in series. This means that **DMX IN** terminals in the device must be provided with a driving cable, and then from **DMX OUT** connector the driving cable must be provided to other DMX receivers.



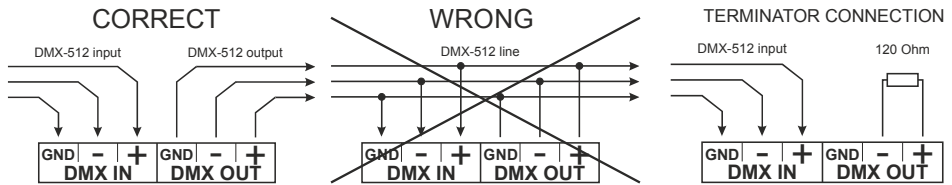







If PX763 is the last device in DMX line, "**DMX+**" and "**DMX-**" terminals must be provided with the terminator-resistor of 120 Ohm.



5 Meaning of displayed messages

- 000** DMX address of the device – the basic position in the MENU
- AB0** setting of the parameters for all channels simultaneously
- AB8** setting of the parameters for each channel separately
- ABF** setting of DMX address
- 0BA** selection of the driving method
- AB5** selection of the response to the lack of DMX signal
- EFF** driving in the effective mode
- BB8** switching on of all outputs at 100%
- BBF** switching off of all outputs
- 528** scene

50H	setting the scene
P00	program no. 17
000	setting of DMX address for the first channel
H00	keeping the last value (in the no signal mode)
360	driving in a 36-channel mode
360	driving in a 36-channel mode plus dimmer
500	the program playing speed
F00	liquidity level of changing the steps in the program
000	setting of brightness of the program
F00	frequency of PWM signals
000	low frequency of PWM outputs
000	high frequency of PWM outputs
500	switching on of the screen backlight
E00	the memory error message
000	the restore default settings menu in the device
500	the function of smoothing of transitions between different values
005	minimum level of brightness
000	white color balance setting
F00	white balance mode
000	white balance off
300	3-channel white balance (for RGB lamps)
400	4-channel white balance (for RGBW lamps)
000	setting red balance
000	setting green balance

-  setting blue balance
-  preview of current temperature inside the device
-  number of the version of the installed software
-  restore default device settings menu
-  confirmation of restoring default settings
-  message confirming restoration of default settings
-  service mode
-  first channel in the service mode
-  setting the inverted characteristics of a dimmer channel
-  setting the normal characteristics of a dimmer channel

6 Device programming

After you switch on the module, its display shows the program version for a brief moment. To access the main menu, press “**enter**”, and the display will show *Adr*. Press “**prev**” or “**next**” to select the appropriate menu and press “**enter**” to confirm your selection.

6.1 Button features

- esc** – goes back to the previous MENU level or discards changes made
- prev** – scrolls to the previous feature on the same MENU level or decreases the parameter's value
- next** – scrolls to the next feature on the same MENU level or increases the parameter's value
- enter** – enters the next MENU level and confirms changes made

6.2 DMX addressing

The menu of the PX763 device allows to set the DMX address of the device between 1 and 512. It is possible to set an address individually *Ind* for one of thirty-six outputs (*C01* – *C36*), in group *ALL* for all channels simultaneously and also to set the address of the dimmer *dim* (888).

IN GROUPS

Set the required DMX address using the keys “*next*” or “*prev*” and select the value from 1 to 476 and press “*enter*”. The set address will be assigned to the first channel, next DMX addresses will be assigned to next channels.

For example, if the value is set on 100, it means that first channel will have an address DMX 100, second 101 ... eight 107, etc.

Once an address is programmed in this manner, the individual settings for each channel are canceled.

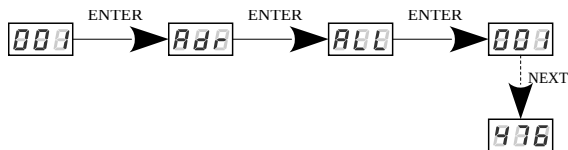

ON AN INDIVIDUAL BASIS

Using this menu you can set a DMX address individually for the 36 outputs. After you select *Ind* in the main menu, press “**enter**” to confirm your selection. Using the “*prev*” or “*next*” keys, select the output you want to configure (*C01* – *C36*) and press “**enter**”.

Using the “*prev*” or “*next*” keys, select a value from the range 1 – 512 and press “**enter**”.

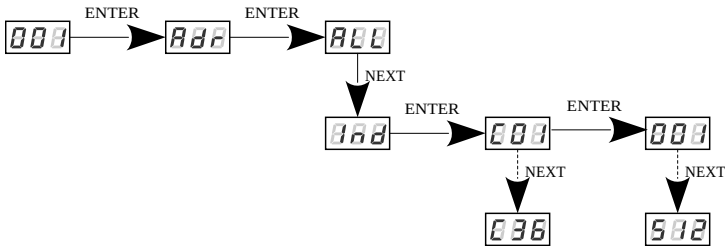

SETTING THE DIMMER ADDRESS

The user has a possibility to set the dimmer address (implicitly it is 512). In order to do it, the control mode *36d* should be selected (36-channel plus dimmer). If the device works in the *36* mode or the *EFF* (effect) mode, the device displays the message 888 in the setting field of the dimmer address. After setting the address of the dimmer channel, its characteristics, normal *nor* and inverted *inv*, can be selected.

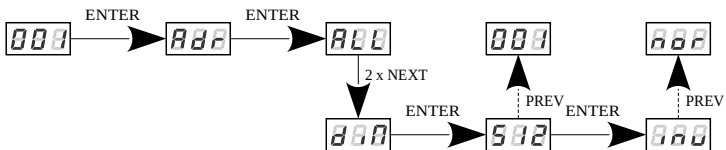

6.3 Operation mode

The PX763 driver can work in the effect mode (**EFF**), the 36-channel one (**36**) or the 36-channel plus dimmer one (**36d**).

In order to select the mode, enter **Cbn** function and then select **36** for the 36-channel mode or **EFF** for the 4-channel mode (effect) and confirm with the key "**enter**".

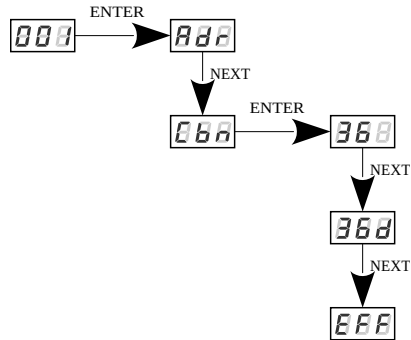

The description of operation of *EFF* 4-byte (effective) mode

The description of the effective mode channels			
CHANNEL 1 – EFFECT	CHANNEL 2 SPEED	CHANNEL 3 FADE	CHANNEL 4 BRIGHTNES S
< 0 – 12 > Program 1	X	X	X
< 13 – 25 > Program 2	X	X	X
< 26 – 38 > Program 3	X	X	X
< 39 – 51 > Program 4	X	X	X
< 52 – 64 > Program 5	X	X	X
< 65 – 77 > Program 6	X	X	X
< 78 – 90 > Program 7	X	X	X
< 91 – 103 > Program 8	X	X	X
< 104 – 116 > Program 9	X	X	X
< 117 – 129 > Program 10	X	X	X
< 130 – 142 > Program 11	X	X	X
< 143 – 155 > Program 12	X	X	X
< 156 – 168 > Program 13	X	X	X
< 169 – 181 > Program 14	X	X	X
< 182 – 194 > Program 15	X	X	X
< 195 – 207 > Program 16	X	X	X
< 208 – 220 > Program 17	X	X	X
< 221 – 233 > Program 18	X	X	X
< 234 – 255 > OFF	–	–	–

CHANNEL 1 – select the effect

CHANNEL 2 – setting of speed (higher value – faster changes)

CHANNEL 3 – setting of fade (higher value – smoother transition)

CHANNEL 4 – setting of brightness (higher value – stronger light)

sign (“x”) – means the ability to drive the parameter of the selected effect

sign (“-”) – means no ability to drive the parameter of the selected effect

6.4 Response to the lack of DMX signal

This function is used both to protect the system against the disappearance of DMX signal and to gain the driving of LEDs without connecting an external driver. After it has been activated, in case of the lack of DMX signal, the module will perform the selected function by itself. Reconnecting of DMX signal will automatically break the performed function, and the module will again send the command with a DMX line.

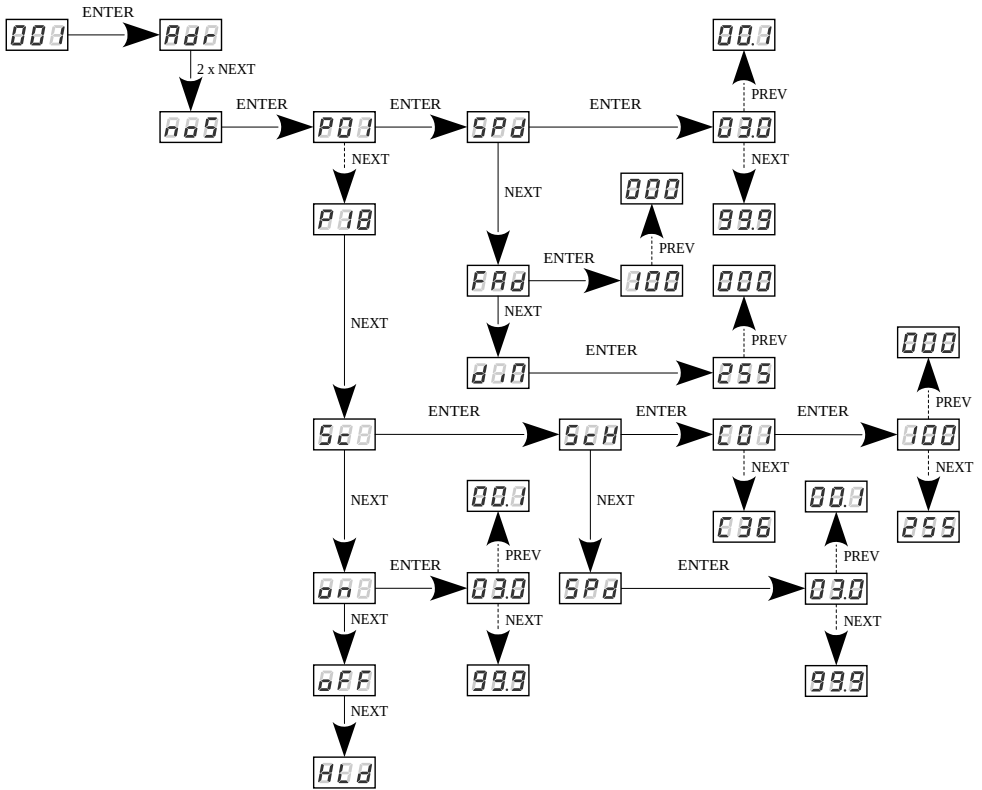

P01 – P18

– you can use 18 ready programs. For each of them there is a possibility to set a playback speed **SPd** (the value from 0.1 and 99.9 seconds), smoothness of step changes in the program **FAd** (from 0 i.e. an abrupt transition to 100 i.e. a completely smooth transition) and a value of dimming **dim** [888] (the value from 0 to 255).

Sc

– programming the value of the scene for individual 36 channels (channels C01 – C36) and also the time of scene entry SPd (the value from 0.1 to 99.9 seconds)

- on** – connecting all the outputs (the value from **1** to **99.9** seconds)
- oFF** – complete switch-off of outputs
- HLd** – maintaining the last value on the channels

6.5 The smoothing function

The device has also the smoothing option. Smoothing allows for smooth brightness and color changes. When the function is on, the transition between further DMX values sent to the lamp (e.g. responsible for brightness) occurs smoothly without obvious jerks, which prevents the effects of "vibrations" in the lighting system. The user can switch off (**OFF**) or select one of four levels of smoothing (**1 – 4**).

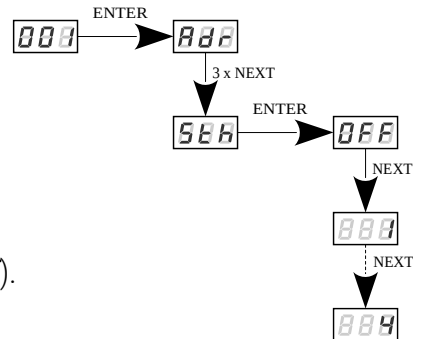

Level **1** – lowest smoothing

Level **4** – highest smoothing

The user can also switch smoothing off (**OFF**).

6.6 Frequency of PWM signals

The *Frq* function allows you to set the base frequency to drive LEDs. This function is extremely useful for applications in the television industry. By using the "flicker free" technology, you can avoid an unpleasant image flicker effect caused by a lack of appropriate synchronization of LED driving signal. The user has two available frequency: 330 Hz (function *Lo*) and 1300 Hz (*Hi*).

The value of frequency in the upper range avoids the flicker effect visible in the cameras.

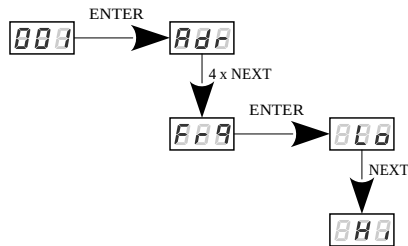

6.7 Minimum level of brightness

The function of setting the minimum level of brightness (*OFS*) has been implemented in the PX763 device, which can be set in the range 0 – 100.

The way it functions is presented in the diagram below:

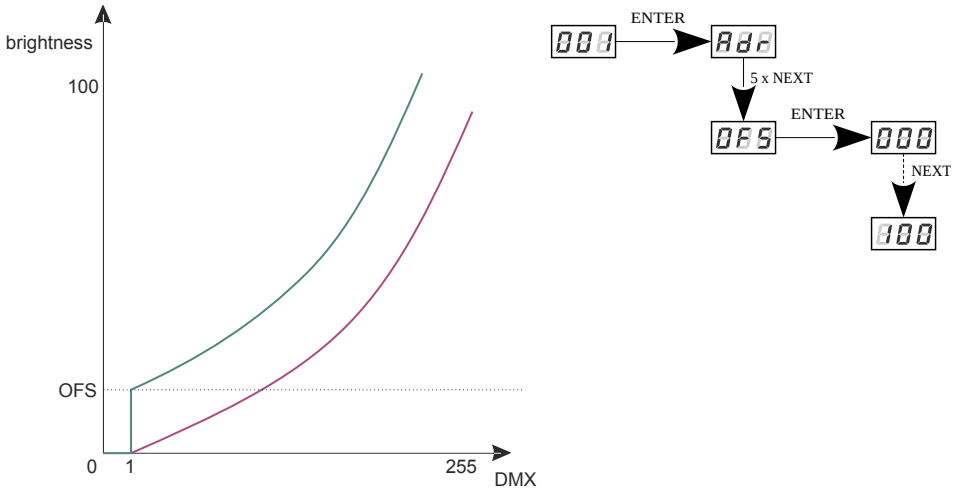

This parameter is useful when the diodes connected to the driver show unstable functioning at the low control levels. In such a case the increase in the value *OFFSET* can result in achieving better dimming effects.

6.8 White balance

Sometimes, there may be problems achieving white color on the LEDs of RGB series. This may be due to the use of diodes with different technical parameters. For this reason, the PX763 module is equipped with a white balance function (***bAL***). This option allows you to select the proper color temperature for the full control of all outputs (white color) in the range of 0 – 100%.

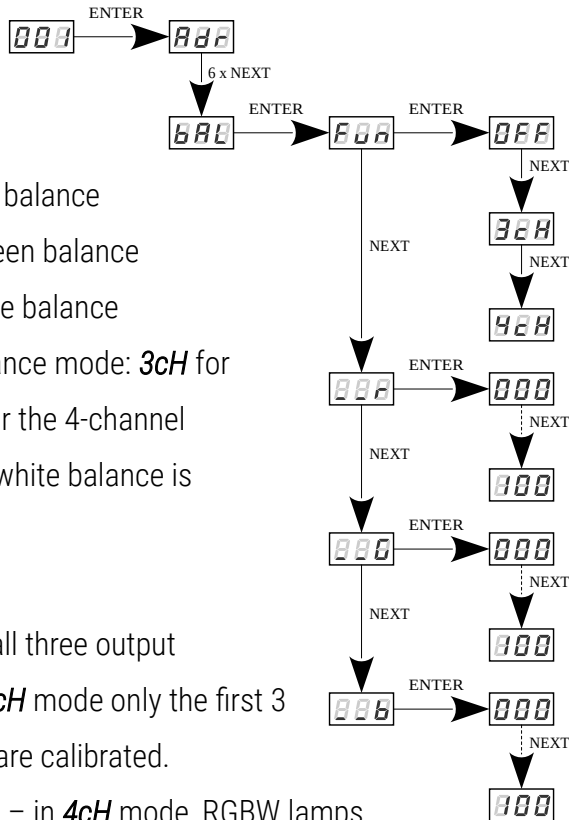

_r – setting the value of the red balance

_G – setting the value of the green balance

_b – setting the value of the blue balance

Fun – selection of the white balance mode: ***3cH*** for the 3-channel RGB mode, ***4cH*** for the 4-channel RGBW mode and ***OFF*** when the white balance is not activated.

When the ***3cH*** mode is chosen, all three output channels are calibrated, in the ***4cH*** mode only the first 3 channels of each four channels are calibrated.

The ***White*** channel is unchanged – in ***4cH*** mode, RGBW lamps should be connected to the next outputs: 1 – 4, 5 – 8, 7 – 12, etc.

6.9 Screen saving

The device is equipped with a feature that allows for turning off the backlight. The **SCr** option activated turns off the display after a minute of inactivity (do not use the keys). The device continues its operation without interfering with other parameters. Press any key to restore the backlight..

on – screen saver activation

oFF – screen saver deactivation

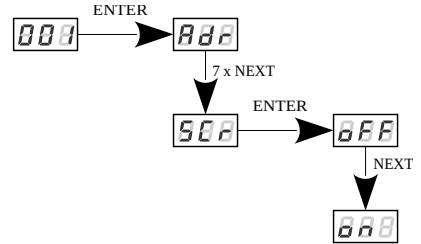

6.10 Temperature

The PX763 was equipped with the possibility to check the temperature inside the device. If the temperature exceeds 70°C, there is a linear limitation of the device power until the outputs will be switched off completely when the temperature reaches 90°C. Additionally, the blinking message **Hot** in the main menu will inform about the increased temperature.

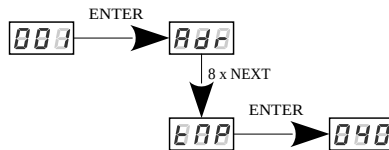

6.11 Default settings and memory error

The device was equipped with the possibility to restore the default values and they can be restored in two ways:

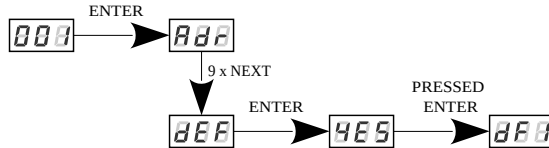

- using the command **dEF** (situated in the menu)
- while turning the device on (using the key "**prev**")

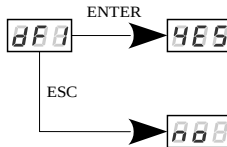

In order to make use of this option, disconnect the PX763 from the mains supply. Before reconnecting it to the mains supply, the key "**prev**" should be pressed and held. Then, after switching on the message **dFI** will appear on the screen of the device (while turning the power supply on to the moment of displaying the message **dFI** the key "**prev**" must be held down).

The default setting in the PX763 are the following:

- the DMX address – 1
- the driver's operational mode 36 – 36
- the operational mode no signal – switched off (**oFF**)
- the smooth functional (**smooth**) – Level 1
- frequency – 330Hz
- the **SCr** option – switched off
- the white balance – switched off (**OFF**)

Err message – memory error

The device is equipped with a built-in memory work control function. If there are problems with the memory operation on the PX763 display, the **Err** message appears – memory error.

In this situation, select the “**enter**” key. The device will reload the default configuration and upload it to the memory. If after this operation, the **Err** message remains on the screen, the memory is permanently damaged and the unit must be sent to the service point.

6.12 Software version

It is possible to check the version of the installed software in the PX763 driver. The **Fir** function allows it.

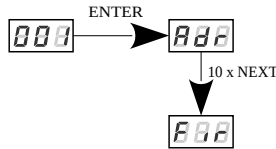

6.13 Rotation of the display

If necessary, you can rotate the display without rotating the whole device. Just hold two middle buttons (“**prev**” and “**next**”) at the same time for approximately 3s.

NOTE! In addition to the display, the order of the buttons is also changed in terms of places.

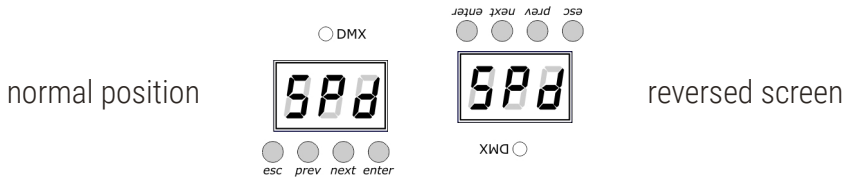

In order to restore the standard setting, hold the middle buttons for approximately 3s.

6.14 Service mode

The service mode allows to turn the chosen channel on for 100% quickly.

NOTE! The input in the service mode disconnects DMX control automatically.

In order to switch it on, go to the initial menu and simultaneously press the keys "*esc*" and "*prev*" longer

The message **000** will appear in the screen, which means that none of the channels is controlled in 100%. Next, enter the selected channel (with the keys "*next*" and "*prev*"). Next channels will be switched on for 100%. In order to output the service mode, press the keys "*esc*" and "*prev*" again.

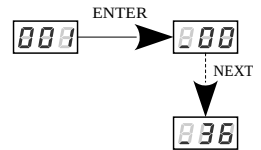

7 RDM description of available parameters

The PX763 supports the DMX – RDM protocol. DMX protocol allows only of a one-way data transmission, while its extension the RDM protocol can transmit information in two directions. This makes possible to simultaneously send and receive information, and hence the possibility of monitoring activities of the compatible devices. Thanks to RDM some available settings of compatible devices may be programmed using this protocol.

Below is a list of RDM parameters supported by the PX763:

Parameter name	PiD	Description
SUPPORTED_PARAMETERS	0x0050	all supported parameters
PARAMETER_DESCRIPTION	0x0051	description of additional parameters
DEVICE_INFO	0x0060	information concerning the device
SOFTWARE_VERSION_LABEL	0x00C0	firmware version of the device
DMX_START_ADDRESS *	0x00F0	DMX starting address of the device; Range 1 – 477 or 1 – 509, depending on the operating mode.
IDENTIFY_DEVICE *	0x1000	device identification; Two states are possible: identification is off (0x00 value) and identification is on (0x01 value).
STATUS_MESSAGES	0x0030	information about device status

Parameter name	PiD	Description
DEVICE_MODEL_DESCRIPTION	0x0080	device description, e.g. name
MANUFACTURER_LABEL	0x0081	manufacturer description, e.g. name
DEVICE_LABEL *	0x0082	additional device description; It is possible to enter an additional device description using up to 32 ASCII characters.
DMX_PERSONALITY	0x00E0	DMX operational mode
DMX_PERSONALITY_DESCRIPTION	0x00E1	description of individual operational modes
SMOOTH: 0FF/1/2/3/4	0x801A	the choice of the option for the Smooth function (smoothing); The OFF function of smoothing is switched off, the values 1 – 4 mean for levels of smoothing.

Parameter name	PiD	Description
NOS[1-22]: P1-18 SC ON OFF/HLD *	0x801C	the choice of the operational mode in case of no DMX signal; The minimum value 1, the maximum value 21. For the values from 1 to 18 the choice of the program from 1 – 18 which is played at the moment of no (or fading) DMX control signal. The scene saved in the PX763 is set for the value of 19, all the outputs are connected with the maximum value (ON) for the value of 20, the channels are turned off for the value of 21, the <i>Hold</i> function is switched off for the value 22 (holding the last value). The default value is 21.
SCREENSAVER: OFF / ON *	0x8024	settings of screensaver; With the 0 value display blanking is not active (OFF), the 1 value means screensaver active (ON). Default value is 0.
PROGRAM_SPEED *	0x8025	setting brightness; The minimum value is 0, and the maximum value is 255. The default value is 128.

Parameter name	PiD	Description
PROGRAM_FADE *	0x8026	setting the transition smoothness between next steps of the program; The minimum value is 0 (the abrupt transition), and the maximum value is 100 (the completely smooth transition). The default value is 100.
PWM_FREQUENCY: LO / HI *	0x8028	frequency of refreshing LED diodes; Where the value 0 corresponds to 330Hz, and 1 corresponds to 1.3kHz
DISPLAY_FLIP: OFF / ON *	0x8038	turning the display on the segment display of the device; The value of 0 is the display working in the normal position, the value of 1 means the inverted display. The default value is 0.
PROGRAM_DIMMER *	0x8032	setting the dimming value; The minimum value is 0, and the maximum value is 255. The default value is 255.
SERIAL_NUMBER	0x8030	device serial number
PWM_FREQ_OFFSET *	0x8055	the minimum level of brightness; The minimum value is 0, and the maximum value is 100.
BALANCE: OFF/RGB/RGBW *	0x8027	to activate or deactivate the balance of output channels; A value of 0 is a balance off, 1 is RGB, 2 RGBW. The default value is set to 0.

Parameter name	PiD	Description
BALANCE RED *	0x8011	value of control level of red channel balance; Minimum value is 0 and maximum is 100 (the value equals to percentage of control level). For the maximum value (100) the LEDs work with maximum brightness. Default value is 100.
BALANCE GREEN *	0x8012	value of control level of green channel balance; Minimum value is 0 and maximum is 100 (the value equals to percentage of control level). For the maximum value (100) the LEDs work with maximum brightness. Default value is 100.
BALANCE BLUE *	0x8013	value of control level of blue channel balance; Minimum value is 0 and maximum is 100 (the value equals to percentage of control level). For the maximum value (100) the LEDs work with maximum brightness. Default value is 100.
INVERT_DIMMER_VALUE: OFF / ON *	0x804F	the function inverting the characteristics of the dimmer channel; the functions to be selected: 0 normal, 1 inverted
DIMMER_ADDRESS *	0x8061	the DMX address of the dimmer channel (1 – 512)

* – parameter editable

9 Connection scheme

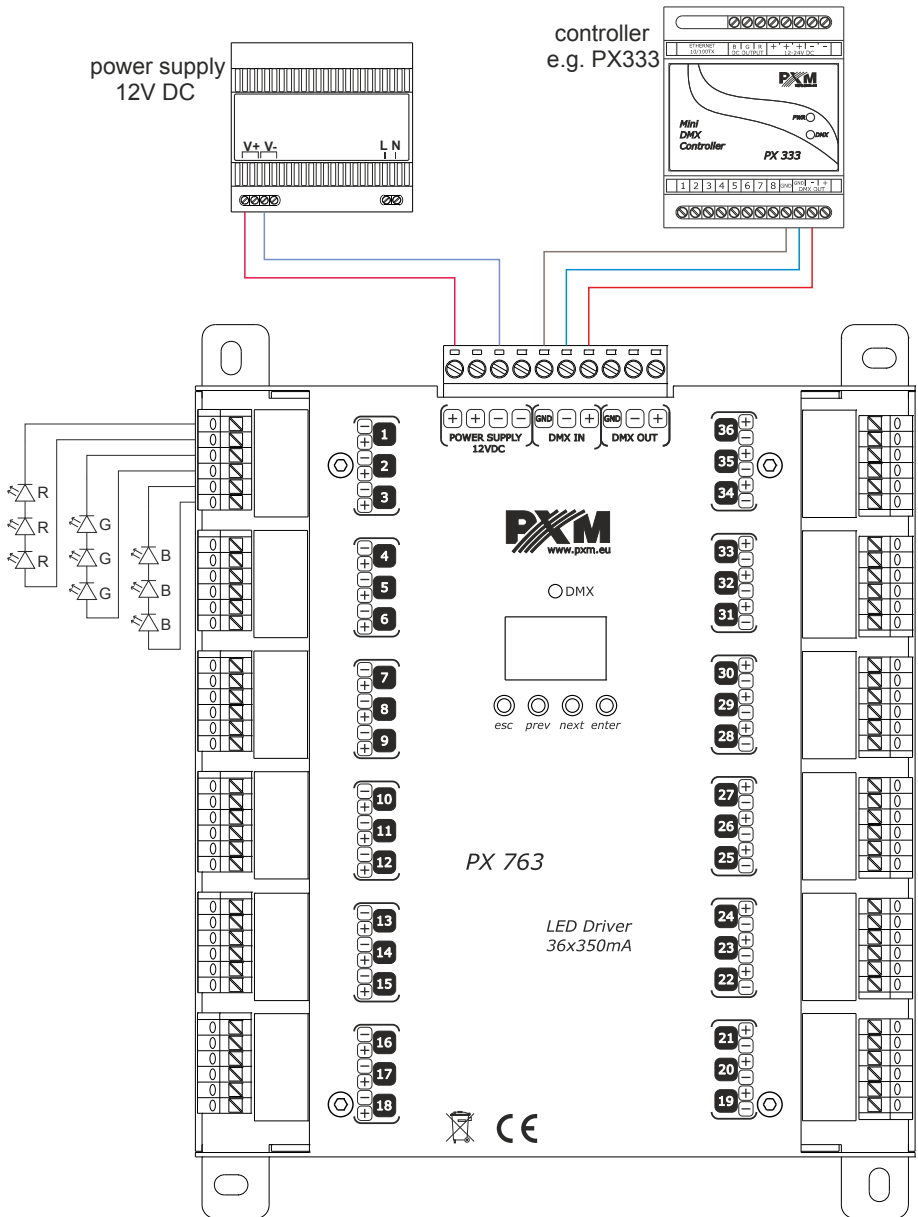

10 Dimensions

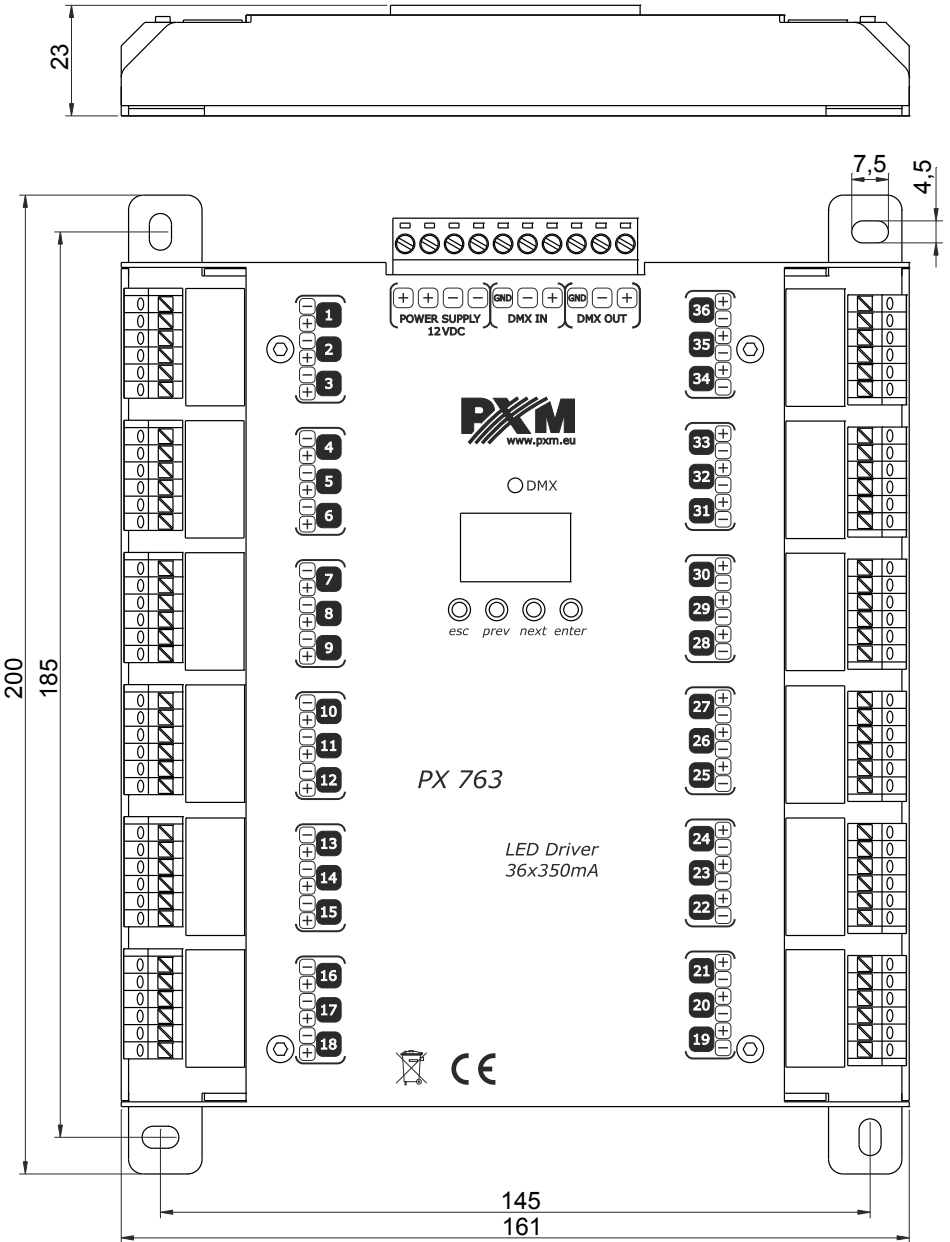

11 Technical data

type	PX763
DMX channels	36 + dimmer (optional)
support for the RDM protocol	yes
power supply	12V DC
max. current consumption	max. 3.8A (in each channel only one LED) max. 12A (in each channel three LEDs)
power consumption without load	0.5W
output channels number	36
outputs load capacity	345mA/channel (+2% ÷ -2%)
weight	0.45kg
dimensions	width: 161mm height: 200mm depth: 23mm

DECLARATION OF CONFORMITY

PXM Marek Żupnik spółka komandytowa
Podłęże 654, 32-003 Podłęże

we declare that our product:

Product name: Driver LED C.C. 36 x 350mA

Product code: PX763

Meets the requirements of the following standards, as well as harmonised standards:

PN-EN IEC 63000:2019-01	EN IEC 63000:2018
PN-EN 61000-4-2:2011	EN 61000-4-2:2009
PN-EN IEC 61000-6-1:2019-03	EN IEC 61000-6-1:2019
PN-EN 61000-6-3:2008	EN 61000-6-3:2007

And meets the essential requirements of the following directives:

2011/65/UE **DIRECTIVE OF THE EUROPEAN PARLIAMENT AND OF THE COUNCIL** of 8 June 2011 on the restriction of the use of certain hazardous substances in electrical and electronic equipment Text with EEA relevance.

2014/30/UE **DIRECTIVE OF THE EUROPEAN PARLIAMENT AND OF THE COUNCIL** of 26 February 2014 on the harmonisation of the laws of the Member States relating to electromagnetic compatibility (recast) Text with EEA relevance.

Marek Żupnik spółka komandytowa
32-003 Podłęże, Podłęże 654
NIP 677-002-54-53



mgr inż. Marek Żupnik.