

PX391

PxArt+ 12

MANUAL



TABLE OF CONTENTS

<u>1. General description.....</u>	<u>3</u>
<u>2. Safety conditions.....</u>	<u>3</u>
<u>3. Version data.....</u>	<u>5</u>
<u>4. Lamp description.....</u>	<u>6</u>
<u>5. Manual change of lamp settings.....</u>	<u>7</u>
<u>6. Co-operation with the PX277 configurator.....</u>	<u>8</u>
<u>6.1 Description of the information parameters.....</u>	<u>9</u>
<u>6.2 Setting lamp parameters.....</u>	<u>9</u>
<u>6.2.1 Lamp colour and brightness address.....</u>	<u>9</u>
<u>6.2.2 Invert colour.....</u>	<u>10</u>
<u>6.2.3 Flicker - Free.....</u>	<u>10</u>
<u>6.2.4 Smoothing.....</u>	<u>11</u>
<u>6.2.5 Smoothing time.....</u>	<u>11</u>
<u>6.2.6 Restoring default settings.....</u>	<u>11</u>
<u>6.2.7 Response to the lack of DMX signal.....</u>	<u>12</u>
<u>7. DMX signal and power supply connection.....</u>	<u>13</u>
<u>7.1 GLOBAL Trac GAC 600 adapter.....</u>	<u>13</u>
<u>7.2 Section through the DMX bus-duct.....</u>	<u>13</u>
<u>8. RDM description of available parameters.....</u>	<u>14</u>
<u>9. Device programming.....</u>	<u>16</u>
<u>10. Dimensions.....</u>	<u>17</u>
<u>11. Technical data.....</u>	<u>18</u>
<u>Declaration of conformity.....</u>	<u>19</u>

Manufacturer reserves the right to make modifications in order to improve device operation.

PXM Marek Źupnik spółka komandytowa
Podłęże 654
32-003 Podłęże

tel.: 12 385 83 06
fax: 12 626 46 94
e-mail: info@pxm.pl
Internet: www.pxm.pl

1. GENERAL DESCRIPTION

PxArt+ 12 is a professional LED illuminator designed for illumination of museum exhibitions or displays.

Thanks to the application of the most modern semiconductor SSL LED light sources and advanced control electronics, a high class illuminator was created which meets very high requirements for museum and exhibition lighting. Its most important advantages include a complete lack of ultraviolet radiation emission, trace amounts of infrared radiation, a very high factor of CRI colour capturing, smooth adjustment of colour temperature of emitted light, large brightness and small energy consumption.

The device features a base which allows for mounting it in GLOBAL Trac® Pulse control bus bars, provided with an additional control line.

Two individual addresses allocated to each lamp allow for independent adjustment of its brightness and colour temperature, regardless of the settings of other lamps.

Through push buttons located on the lamp casing it is possible to operate it manually (e.g. in case of connecting the lamp to bus bars without a control line).

Highly-effective LEDs made by Osram Oslon® are used in the lamp with an efficient control system, through which the lamp emits small amounts of heat.

The lamp casing renders it possible to change the direction of its beaconing in two axes.

2. SAFETY CONDITIONS

Caution! Before installing, connecting, using and maintaining the lamp, you must absolutely read this document.

The following symbols are used to emphasise important information on security conditions on the product and in this manual.



Danger!
Risk of loss of life and health.



Warning!
Fire hazard.



Warning!
LED light emission.
The risk of eye damage.



Warning!
The risk of burns.



Warning!
Read this instruction manual.

Caution!

Do not look at the LEDs at a shorter distance than 2.0 m from the front surface of the tube without proper eye protection. At a shorter distance, LEDs can cause damage or eye irritation. Do not look at the light source directly through any optical instruments, which focus the light rays.



From a distance of more than 2.0 m from the outer housing of the lamp and LEDs, the light is harmless to unprotected eyes.



While working outdoors in normal conditions, the housing unit can heat up to +60°C. Make sure that accidental contact with the device during use is impossible.



In case of improper usage of the product it may cause a risk of serious injury or death, because of the threat of fire.



PX391 is powered directly from a standard 230 V grid. Failure to observe safety instructions may result in electric shock and pose a threat to life.

Therefore, it is necessary to observe the following rules:

1. Installation should be performed by a person holding the appropriate qualifications, according to the instruction manual.
2. Lamp can be connected only to a grid which meets the safety conditions (3-wire grid, equipped with a circuit breaker).
3. Protect all cables against mechanical and thermal damage.
4. In case of failure of any of the cables, it must be replaced with a cable of the same technical parameters.
5. All repairs can only be carried out with power disconnected.
6. The device with visible mechanical damage cannot be connected to the mains.
7. Avoid sudden shocks, particularly dropping.
8. The device must not be used in rooms with a temperature below 2 °C or above 40 °C.
9. Clean only with a damp cloth – the lamp must be at this time completely disconnected from the power supply.

The dimming of the lamp brightness occurs when the temperature is above 70 °C; this prevents the device from overheating. If the device reaches a temperature of 90 °C, the power of the lamp will be totally reduced. The light is then switched automatically in the event of temperature drop below the maximum temperature (90°C). The higher the temperature of the device, the greater is the brightness dimming.

3. VERSION DATA

There are several versions of the PX391 lamp which are different from each other as far as the type of the reflector applied.

Below there is a description of designations of PX391 models with explanation:

PX391-XX-YY-Z

XX - the reflector angle

10 - 10°

20 - 20°

30 - 30°

40 - 40°

EL - elliptical

WW(50x110°) - Wall Washer

YY - colours of applied LEDs

MW - multi white (dynamic white)

MC - color (RGB)

Z - housing colour

1 - grey

2 - black

3 - white

Example of lamp designation:

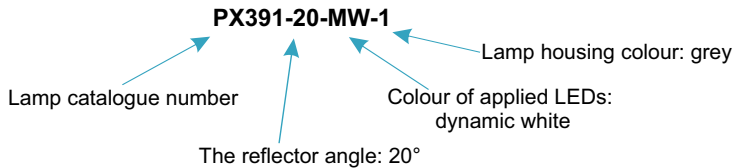

4. LAMP DESCRIPTION

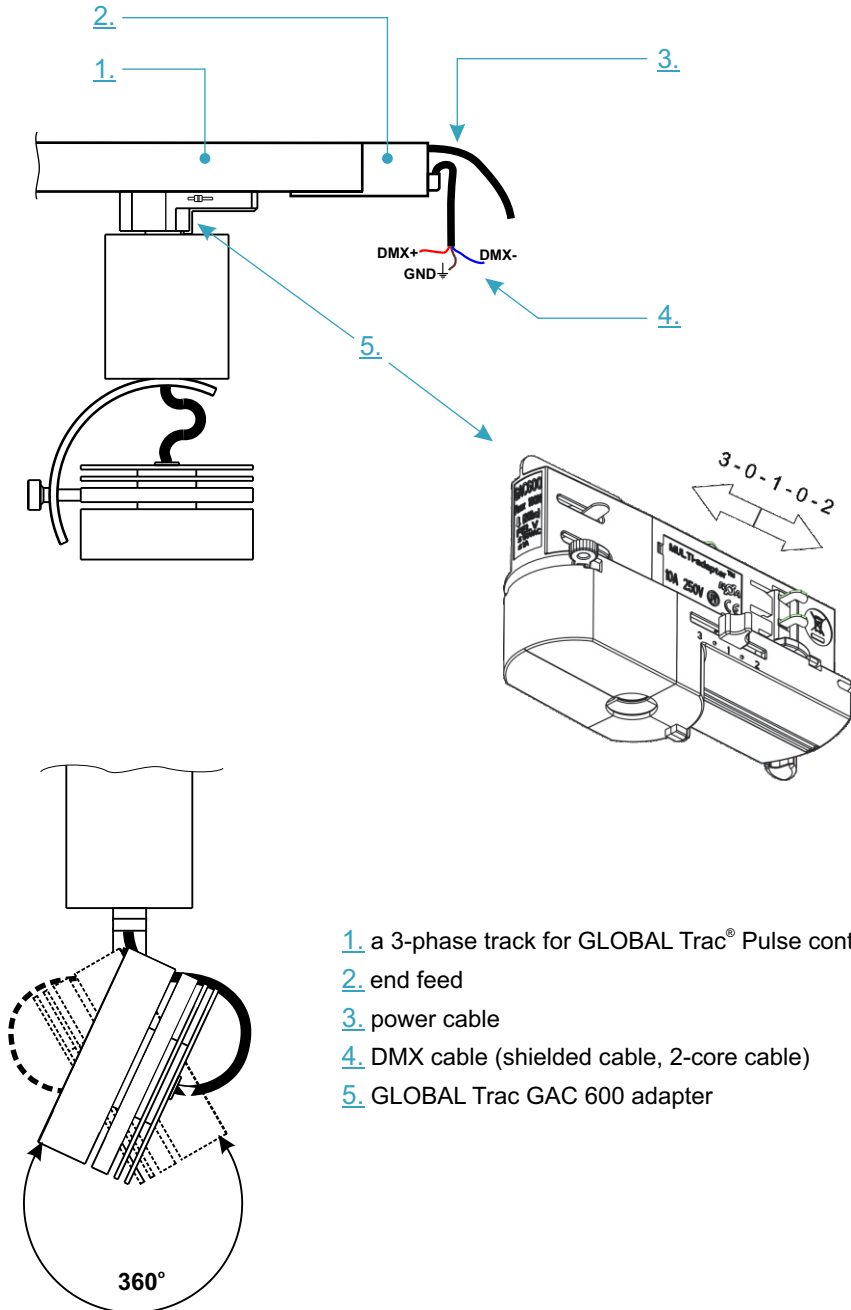

1. a 3-phase track for GLOBAL Trac® Pulse control
2. end feed
3. power cable
4. DMX cable (shielded cable, 2-core cable)
5. GLOBAL Trac GAC 600 adapter

5. MANUAL CHANGE OF LAMP SETTINGS

The lamp has been equipped with buttons which allow for changing the brightness level and colour temperature of light. The buttons have been placed at the bottom part of the junction box, above the lamp reflector. One button is responsible for one parameter.

The available buttons and connector for connecting the PX277 programmer have been shown in the figure below:

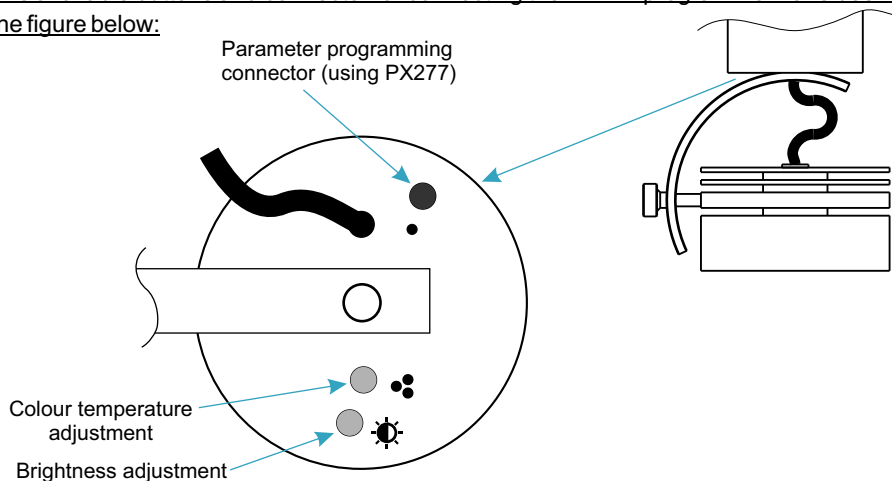

Above the reflector there is a diode which indicates the condition of the lamp.

Depending on a situation, the diode signals the following:

- start of the lamp – quick flickering of the diode for 2 seconds
- DMX signal receiving – slow flickering of the brightness adjustment button (1Hz frequency) in the first minute after receiving the DMX signal,
- after the start of the lamp in case of the loss of DMX signal – diode lights (continuously) for 1 minute,
- if the state of DMX signal is changed (if there was no DMX signal and it returned, or vice versa) – diode signals it for 1 minute,
- damage of the temperature sensor module – diode does not go out after 1 minute.

To change the brightness or temperature colour, press and hold down the appropriate control button. If during the brightness or colour temperature adjustment the button diode starts flickering, it means that the extreme value (minimum or maximum) has been reached. Then the direction of adjustment changes.

It is possible to change the adjustment direction without reaching extreme values. For example, while the lamp brightness is increased, release the control button for a moment. The diode will signal the change of adjustment direction. The pressing of the adjustment button again will cause the dimming of the lamp (brightness decrease).

While the lamp operates, the diode stays switched off (excluding situations mentioned above).

For lamps with RGB LEDs configuration, programming buttons available under the reflector have the following functions:

- colour temperature adjustment button - change of light colour
- brightness adjustment button - change of the brightness value

6. CO-OPERATION WITH THE PX277 CONFIGURATOR

Lamp settings can be changed by connecting the PX277 PxArt Settings Controller configurator. At the moment of connection, the PX391 starts again which causes LEDs to be off for a while and the diode indicating the DMX signal condition pulses for 2 seconds.

When the device is turned on, its name appears on the display. The main menu allows a preview of many lamp parameters from PxArt series and a change of the following options: colour and brightness address, scene brightness and colour, colour inversion, smoothing, change of smoothing time, Flicker free and restoration of default parameters.

Furthermore, it is possible to check the lighting time and lamp operation time (total lamp operation time, also without switching the diodes off). Additionally, information concerning minimum, maximum and current temperature reached by the lamp is displayed.

PxArt Settings Controller also allows for checking the version number of the software which is installed in the lamp, its serial number and model.

Navigating through the menu is possible with programmer buttons located below the display. The "escape" button allows an exit to the upper level in the device menu; "next" and "previous" buttons make it possible to go forward and backward (alternatively value decreasing or increasing). However, the "enter" button allows you to enter the edition of the selected menu or to confirm the edited value.

Setting lamp parameters - DMX signal value:

	Lamp parameter value	DMX signal value	
		Invert colour Turning off	Invert colour Turning on
Colour temperature adjustment (Lamp colour)	4500K	255	0
	⋮	⋮	⋮
	3600K	128	128
	⋮	⋮	⋮
	2700K	0	255
Brightness adjustment (Lamp brightness)	100%	255	
	⋮	⋮	
	50%	128	
	⋮	⋮	
	0%	0	

6.1. Description of the information parameters

PX277 controller allows you to read important information concerning the lamp to which it has been connected.

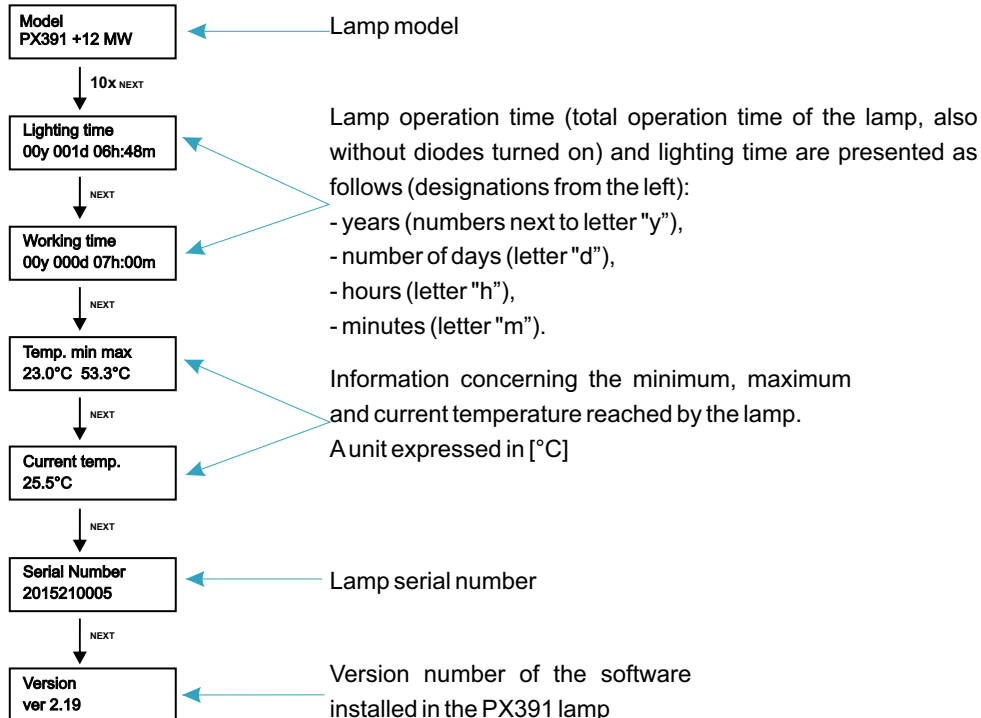

6.2 Setting lamp parameters

6.2.1 Lamp color and brightness address

PX277 allows for changing the DMX address which controls the color and brightness of the lamp. The lamp has the DMX channel assigned whose value can be changed depending on the needs. DMX channel can be set between 1 to 512.

To change the DMX channel (which is responsible for the lamp function), select in the PX277 menu a [Color address] or [Bright. address] option, confirm by pressing "enter" and then set an appropriate value using "previous" and "next" buttons. After the change of the DMX channel, the operation has to be confirmed by pressing "enter".

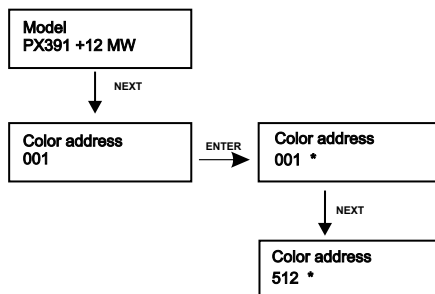

6.2.4 Smoothing

The device also has the smoothing option which enables smooth brightness and colour modifications. When the function is turned on, the transitions between successive DMX values sent to the lamp (responsible for brightness and colour changes) occur smoothly, without visible jolts, which prevents light "vibration" effects in the lighting systems.

The next two DMX values sent to the lamp are linearly smoothed between DMX signal packets for the selected option [P2P] or the time interval set in the menu [Time].

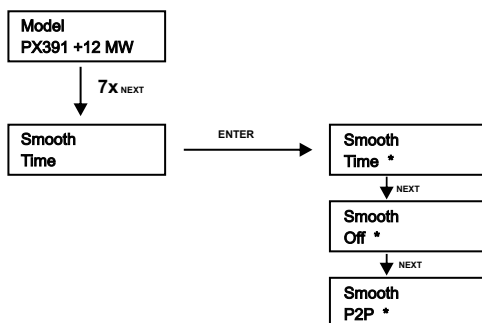

6.2.5 Smooth time

When the PxArt Settings Controller time smoothing function is active, it allows for changing the smoothing time value. As a result it enables an acceleration or deceleration of the brightness and colour parameter change. Maximum available value is 2000 [ms] and minimum is 10 [ms].

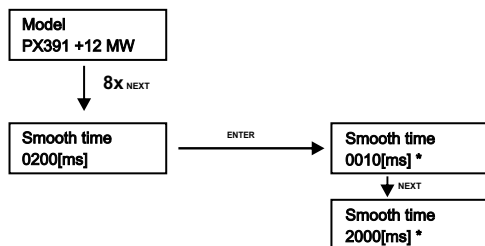

[**Smooth time**] - makes it possible to change the time parameter at which subsequent different DMX signal values sent to the lamp are smoothed among themselves. The user may set the smoothing time using "previous" and "next" buttons.

6.2.6 Restoring default settings

The device comes with the option to restore default settings.

To use this option, select the [Default sett.] menu and press "enter".

A window informing about the need to press "previous" and "next" buttons will appear for 2 seconds simultaneously. Next, the device will display [Reset OK...] message and default settings will be restored.

PX391 default setting:

- Color address 001
- Brightness address 001
- Scene color 128
- Scene brightness 128
- Invert color Off
- Flicker free On
- Smooth Time
- Smooth time 200 [ms]

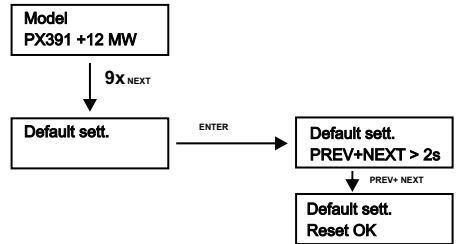

6.2.7 Response to lack of DMX signal

In case of no DMX signal, the scene executed is the one whose parameters are adjusted by the user using **[Scene color]** and **[Scene brightness]** options. This function is used to gain control of LEDs without connecting an external controller.

Automatic connection of DMX signal will stop the executed scene and the lamp will operate in accordance with the parameters of the control signal.

The change of scene colour and brightness is possible directly from the lamp (buttons) or with the use of PX277. These values can be set between 0 and 255.

[Scene color] – if set to 0, changes the colour temperature value of the lamp to warm, and 255 to cold. 128 sets the neutral colour temperature. Values between the above values correspond to the colours between the described extreme colours (warm white and cold white). If the **[Invert colour]** option is enabled, the warm temperature colour of the lamp has the value of 255, and cold – 0.

[Scene brightness] – if set to 0, it turns off the scene, and 255 turns it on at 100%. 128 means that the scene brightness is set to 50%. After changing the value of scene brightness, the operation has to be confirmed by pressing "enter" or "escape".

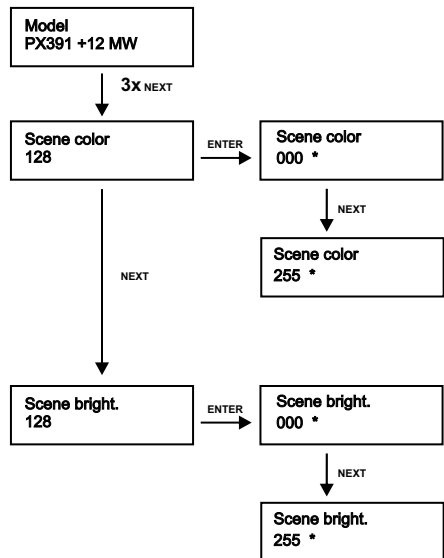

7. DMX SIGNAL AND POWER SUPPLY CONNECTION

7.1. GLOBAL Trac GAC 600 adapter

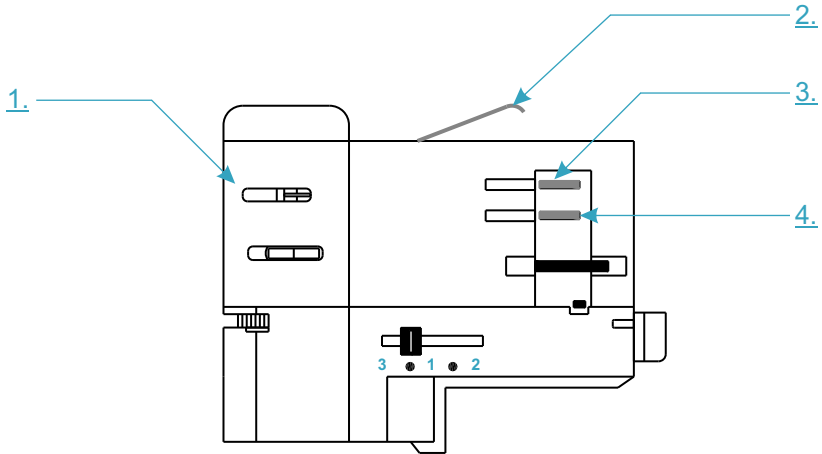

DMX CONTACTS:

- 1. DMX - (on the opposite side DMX +)

POWER CONTACTS:

- 2. earth \oplus
- 3. phase 1 (phase 2 on the opposite side)
- 4. neutral (phase 3 on the opposite side)
- 5. phase selector switch

7.2. Section through the DMX GLOBAL Trac[®] Pulse control bus-duct

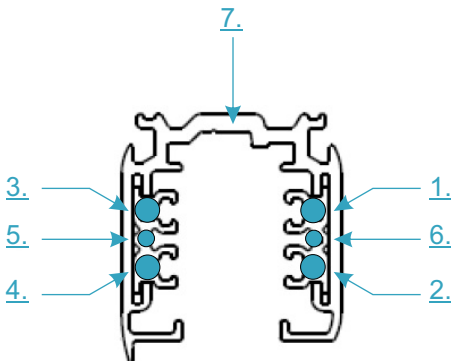

POWER:

- 1. phase 2
- 2. phase 3
- 3. phase 1
- 4. neutral

DMX:

- 5. DMX-
- 6. DMX-
- 7. GND

8. RDM DESCRIPTION OF AVAILABLE PARAMETERS

PX391 supports the DMX-RDM protocol. DMX protocol in its assumption enables one-way data flow while its extension, the RDM protocol, can transmit information in two ways. This makes the simultaneous receiving and sending of information possible and allows for monitoring the operation of devices compatible with the RDM protocol as well as gives the possibility of changing the configuration of their parameters.

Below there is a list of RDM parameters supported by PX391:

Parameter name	PiD	Description
SUPPORTED_PARAMETERS	0x0050	all supported parameters
PARAMETER_DESCRIPTION	0x0051	description of additional parameters
DEVICE_INFO	0x0060	information concerning the device
SOFTWARE_VERSION_LABEL	0x00C0	firmware version of the device
DMX_START_ADDRESS *	0x00F0	DMX starting address of the device, minimum value: 1, maximum value: 512. According to the RDM standard, for device whose footprint is 0, the value of this parameter may be 65535 and then it is not possible to change the initial address settings for the entire device, but only for sub-devices.
IDENTIFY_DEVICE *	0x1000	device identification, Two states are possible: identification is off (0x00 value) and identification is on (0x01 value).
DEVICE_MODEL_DESCRIPTION	0x0080	device description, e.g. name
MANUFACTURER_LABEL	0x0081	manufacturer description, e.g. name
DEVICE_LABEL *	0x0082	additional device description, It is possible to enter an additional device description using up to 32 ASCII characters.
FACTORY_DEFAULTS	0x0090	device default settings
DMX_PERSONALITY	0x00E0	DMX operational mode
DMX_PERSONALITY_DESCRIPTION	0x00E1	description of individual operational modes
SENSOR_DEFINITION	0x0200	information concerning the selected temperature sensor
SENSOR_VALUE	0x0201	information concerning sensors
DEVICE_HOURS	0x0400	information concerning the working time of the device counted in hours
LAMP_HOURS	0x0401	information concerning lamp lighting time

Parameter name	PiD	Description
TEMPERATURE_LIMIT_ON/OFF	0x800E	temperature limitation activation for the temperature sensor connected to the driver, For 0 value, the function is not active; for 1 value, the function is active. Default value is 1.
TEMPERATURE_THRESHOLD_LOW	0x800F	lower temperature value for which the temperature limitation is being activated
TEMPERATURE_THRESHOLD_HIGH	0x8010	upper temperature value for which the temperature limitation is active, i.e. the cut-off temperature for exits from the driver
SMOOTH_DIS_0/P2P_1/TIM_2 *	0x801A	selection of the options concerning Smooth function, For 0 value, the smooth function is off; for 1 value, the smooth function operates in the Packet to Packet mode (P2P) and for 2 value, the smooth function operates in the time mode. Value 0 set by default – smoothing off.
SMOOTH_TIME *	0x801B	smoothing time for TIM (time) function selected in the above point, Unit expressed in [ms]. Minimum parameter value is 10 and maximum is 2000 [ms]. Default value is 200 [ms].
SCENE_COLOR *	0x8021	color temperature settings, Minimum value: 0, maximum value: 255. Default value is 128.
SCENE_BRIGHTNESS *	0x8022	brightness settings, Minimum value: 0, maximum value: 255. Default value is 128.
FRICKER_FREE_ON/OFF *	0x8023	elimination of the flickering effect, For 0 value, the function of eliminating the flickering effect is disabled, and for 1 value, it is enabled. Default value is 1.
SERIAL_NUMBER	0x8030	device serial number
INVERT_COLOR_ON/OFF *	0x8038	inversion of the light colour characteristics, For 0 value, this function is disabled, and for 1 value, it is enabled. Default value is 0.

* - parameter editable

9. DEVICE PROGRAMMING

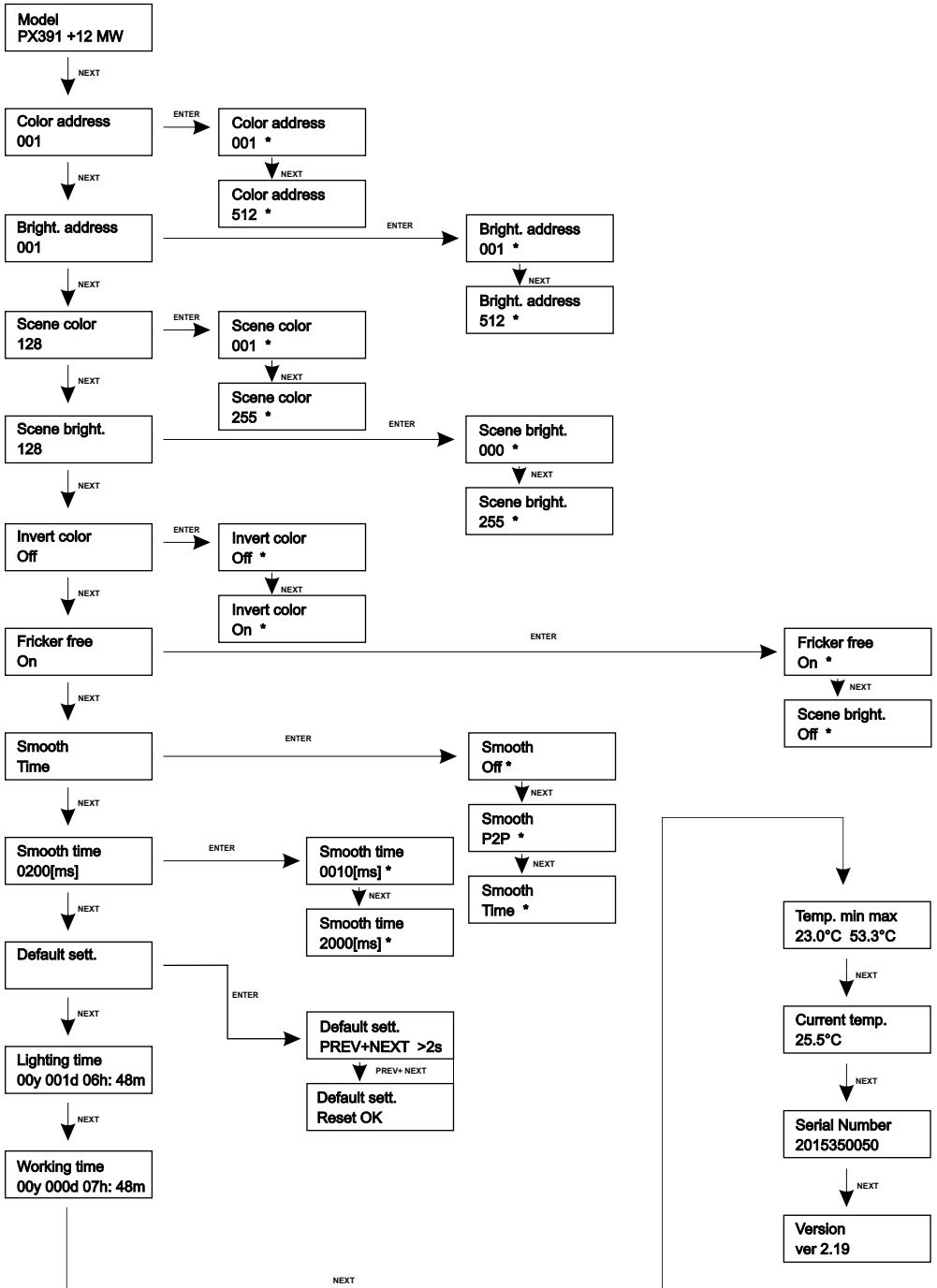

10. DIMENSIONS

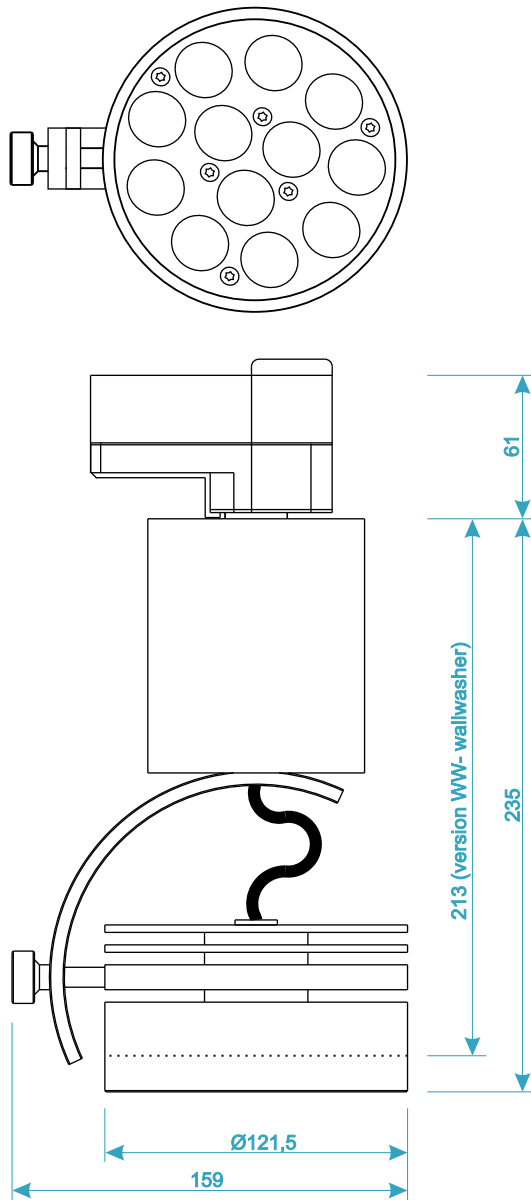

Dimensions are given in millimetres

For the lamp equipped with the WW (Wall Washer) type optics, the light appearance and its dimensions differ slightly

10. TECHNICAL DATA

Power supply: 230 V AC

Number of LEDs: 12

Power input: 17,5 W

Max. increase of the housing temp.: + 30° C

Luminous flux: 1200 lumens

Lifetime of diodes: 50 000 h

Angles of reflectors: 10°, 20°, 30°, 40°, EL, WW (50x110°)

Color temperature: 2700÷4500 K
(6000 K on order)

Brightness regulation extension: 0÷100%

CRI colour rendering index CRI: min. 90

Control protocol: DMX-512 / RDM

Available housing colours: Silver, black, white

Weight: 1,65 kg

Dimensions: Width: 159 mm
Height: 235 mm
Diameter of the reflector: 121,5 mm

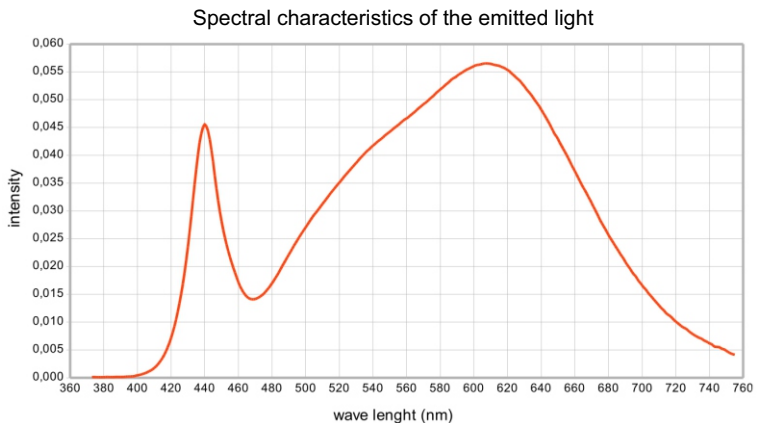



ul. Przemysłowa 12
30-701 Kraków

tel: 12 385 83 06
fax: 12 626 46 94

e-mail: info@pxm.pl
http://www.pxm.pl

DECLARATION OF CONFORMITY

according to guide lines 2004/108/WE and 2006/95/WE

Name of producer: PXM Marek Żupnik sp. k.

Address of producer: ul. Przemysłowa 12
30-701 Kraków

declares that the product:

Name of product: **PxArt+ 12**

Type: **PX391**

answers the following product specifications:

LVD: PN-EN 60598-1:2011
PN-EN 62471:2010

EMC: PN-EN 61000-4-2:2011
PN-EN 61000-6-1:2008
PN-EN 61000-6-3:2008

Additional informations:

Pay attention to the correct connection of power cables.

Maintenance can be performed only while the current rails system is off.

DMX signal has to be connected by using a shielded cable connected to the GND pin.



Marek Żupnik spółka komandytowa
30-701 Kraków, ul. Przemysłowa 12
NIP 677-002-54-53

Kraków, 18.05.2015

mgr inż. Marek Żupnik